



# HEALTH CARE PATIENT AIDS



**micr****line**

Material médico e científico Lda

## MANUAL AND ELECTRIC LICE COMB

Natural, ecologic method to eliminate completely lice and nits without any harm. Ideal for allergy sufferers and children.

### • 24400 MANUAL LICE COMB - blister

Ergonomic comb with long metal teeth and a detachable cleaning brush with built-in magnifier. The long, delicately closed teeth of the comb are designed specifically to detach lice and their nits (tiny eggs). The round form of the touching point respects the growth direction of the hair without harming its texture. Multilingual blister: GB, FR, IT, ES.

Free display box any 10 blister



24400

Detachable cleaning brush with built-in magnifier



24400

### • 24403 ELECTRIC LICE COMB - IT, ES

### • 24405 ELECTRIC LICE COMB - GB, FR

This innovative product eradicates and kills lice and nits with a quick increasing electrical discharge of 100-250 Volts from the teeth, imperceptible and harmless to humans. Auto switch off. Provided of buzzer indicator and LED light. Supplied with cleaning brush, 1 AAA battery, multilingual manual in a multilingual blister.



24403, 24405

Size:

10.36x7.57x2.66 cm

## DEVICES AGAINST INSECTS

25771

CE 0051

- 25770 ZANZA-CLICK AFTERBITE - IT - green
- 25771 ZANZA-CLICK AFTERBITE - GB - blue

A few clicks to soothe itching and swelling caused by mosquito bites. MDR Certified

• 25772 BABYFRIEND Ultrasonic repelling device against mosquitoes. Suitable for a 15 m<sup>2</sup> room.



25772

## UNSTINGER®

### • 24395 UNSTINGER®

Insect poison extraction tool. An easy and painless way to avoid the discomfort that follows from bites and stings by bees, wasps, hornets and even scorpions or snakes. Reusable one-hand operated vacuum pump which easily and painlessly extracts poison and venom from a sting or bite. Multilingual box and manual: GB, FR, IT, ES.



24395

## TICK TWEEZER

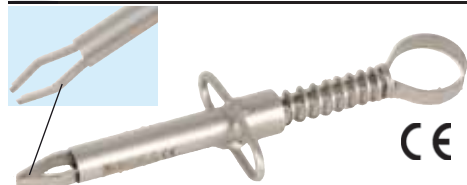

• 24390 TICK TWEEZER - 8,5 cm  
Intended for holding and removal purpose. Made of stainless steel.

## SPLINTER



• 24391 SPLINTER WITH MAGNIFYING GLASS 2X - 8 cm  
Magnifying glass splinter tweezer made of stainless steel.

## DENTAL HYGIENE

36655

### • 36655 GERMORAL MOUTHWASH - bactericidal mouthwash One display contains 12 bottles of 300 ml

For daily oral hygiene, Germoral prevents and acts against the formation of bad breath because it stops fermentation in the oral cavity. It performs an antiplaque and hygienic action. Suitable for smokers, prosthesis or paradontic teeth users or after dental surgery for disinfecting the oral cavity. If regularly applied it prevents and acts against inflammations, gingival disorders, dental plaque formation.



## ECOSAVE FOR POISONOUS BITES

### • 25773 ECOSAVE AGAINST POISONOUS BITES

Pocket-size electronic device that produces - through two electrodes - short discharges (lasting ten microseconds approx. at one second regular intervals) able to reduce local symptoms - pain, burning, redness, swelling - caused by bites and/or stings from insects and other animals, such as hymenopterans (e.g. bees, wasps, bumble-bees, etc.), arachnids (e.g. scorpions, spiders, etc.), marine animals (e.g. fishes, jellyfishes, stinging coral), snakes venom. First aid tool, used while waiting for intervention of a doctor. Not intended for allergic reactions in allergic people. It is not effective against neurotoxic venom (some kinds of snakes, like cobra, mamba and some tropical animals). MDR Certified



25773

CE 0051

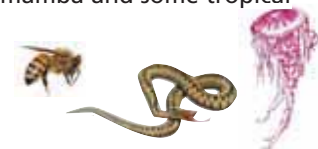

ELECTRIC STIMULATION TO REDUCE POISONOUS BITES EFFECTS

# VISIOFOCUS® AND VISIOFOCUS® PRO "NON CONTACT" THERMOMETERS



CE 0051 MDR Certified  
MADE IN ITALY

- 25573 VISIOFOCUS®
  - 25574 VISIOFOCUS® PRO
- High accurate "non contact" thermometer that projects the temperature on the forehead.

**Advantages of VisioFocus®:**

- exclusive patented aiming system guarantees correct reading point and distance
- projection of the temperature on the forehead
- face button automatically adjusts forehead temperature to the environment (room) temperature for accurate result
- exclusive and patented AQCS and MQCS systems to maintain correct and constant temperature of device during long periods of use or when moving between rooms with different temperatures
- clinically tested
- totally hygienic for patients and users: no touch, no disposables
- no laser: absolutely safe for patients and users, no harm if the person eyes are open while measurement is taken
- instantaneous: gives temperature in less than 1 second
- Nurs and Doct functions (only 25574) for professional and intensive use as pandemic situations: allow to take temperature of up to 1,000 people per hour. Nurs has obliged MQCS every 30 minutes, in Doct mode MQCS is not mandatory, MQCS and AQCS are available



25573

- low using cost thanks to the long battery life and speed of measurement that allows to reduce the number of thermometers and of operators necessary for a wide screening



25573 Visiofocus® is supplied with batteries and manual (GB, FR, IT, ES)



25574 Visiofocus® Pro is supplied in a case with lanyard, batteries and manual (GB, FR, IT, ES)

**BACKLIGHTED DISPLAY IN 5 DIFFERENT COLOURS, ONE FOR EACH FUNCTION**

BODY TEMPERATURE	OBJECTS	MEMORY	AMBIENT	CALIBRATION MQCS

**TECHNICAL SPECIFICATIONS**

Forehead measuring range	34.0 /42.5°C (93.2/108.5°F)
Measuring range (apart from forehead)	1.0/80°C (33.8/ 176°F)
Room temperature working range	16/40°C (60.8/104°F)
<i>The 25573 can operate also from 10 to 45°C (41-113°F) and the 25574 also from -10 to 45°C (-14-113°F), but out of the range 16-40°C (60.6-104.1°F) the accuracy is not guaranteed.</i>	
Resolution	0.1°
Accuracy level	According to ASTM E 1965-98:2016 and EN 80601-2-56
Distance of operation:	About 6 cm (2.36")
Batteries (included)	4 AAA/LR03 type (preferably alkaline)
Batteries life	30,000 readings or up to 3 years
Measurement time	<0.5 seconds
Time between consecutive measurements	<2 seconds

# RI-THERMO® SENSIOPRO NON CONTACT INFRARED THERMOMETER

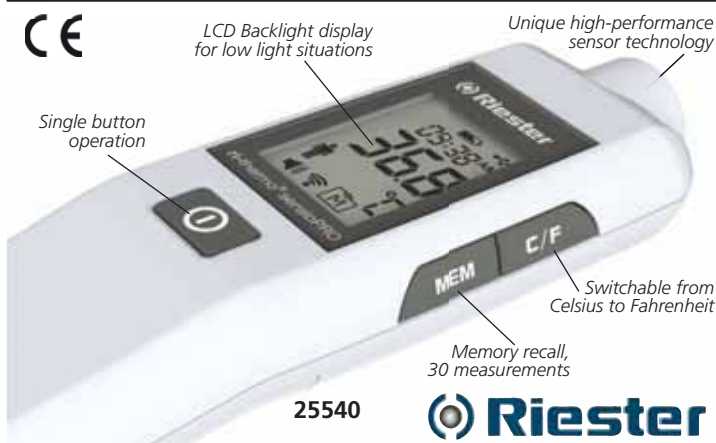

25540



**• 25540 RI-THERMO SENSIOPRO NON-CONTACT INFRARED THERMOMETER**

Contactless, accurate and fast thermometer, helping minimize cross contamination. Clinical grade forehead temperature measurements, calibrated to an oral body temperature reference. Optimized for professional.

**Features:**

- clinical grade reading in 1-2 seconds
  - ISO standards 80601-2-56:2017
  - safe and efficient
  - infrared non-contact helps preventing cross contamination
  - 3000 measurements on one set of batteries
  - 30 measurement storage
  - backlit LED screen
  - single hand operation
- Multilingual manual: GB, FR, IT, ES, DE, RU.

**TECHNICAL SPECIFICATIONS**

Measurement range:	Forehead: 22 - 44°C
Accuracy:	Forehead: 36 - 39°C ±0.2°C, < 36°C or > 39°C
Operating Temperature:	10 to 40°C (50 to 104°F), 95% RH or less
Resolution:	0.1°C / 0.1°F
Measurement Unit:	°C (Default) / °F
Hi/Lo Indicator:	34 to 43°C (93,2 to 109°F)
Power Source:	Two 1.5 V AA Batteries (non-rechargeable)
Battery Life:	Approximately 3000 measurements
Memory Capacity:	Allows memory recall, 30 previous measurements
Power saving:	Automatic power off after 30 seconds
Measuring distance:	Approx. 3 - 7 cm
Dimension / Weight:	150 (L) x 48.5 (W) x 55 (H) mm / 125.8 g (with battery)
Standards:	ASTM E1965-98 and EC directive 93 / 42 / EEC



## OMRON GENTLE TEMP® 720

• 25611 OMRON GENTLE TEMP® 720 NON CONTACT THERMOMETER

Gentle Temp® 720 is a superfast accurate infrared non contact thermometer. It is intended to measure body, surface and room temperature. It can memorise up to 25 readings, track temperature changes over a period of time and monitor trends. In addition to the forehead mode, it can also be switched to surface measurement mode, which shows the actual and unadjusted surface temperature. It helps to determine if the object temperature (for example a milk bottle or food dispenser) is suitable for the patient or the baby. Room temperature is always displayed. It is intended for home use. Reading scale °C/°F is switchable. Supplied with 1 battery, probe cap and multilingual instructions manual: GB, FR, IT, ES, DE, NL, RU, TR, Arabic.



25611



3 APPLICATIONS:  
FOREHEAD, SURFACE, ROOM

### TECHNICAL SPECIFICATIONS

Measurement type:	contactless 3 in 1 (forehead, surface, room)
Measurement range/accuracy:	forehead 34.0 - 42.2°C (93.2-108.0°F) / ± 0.2°C surface -22.0 - 80.0°C (-7.6° - 176.0°F) / ± 0.3°C room 10 - 40°C (50°-104°F) / ± 2°C
Auto power off time:	1 min
Measuring time:	1 second
Measuring distance:	1-3 cm (0.4-1.2 inch)
Temperature mode:	°C/°F
Memory:	25 readings
Display:	backlight
Battery:	3.0V DC, 1 CR2032 (code 32212) lithium button battery battery life: approx. 2,500 measurements
Classification - protection:	Type BF - IP22
Size - weight:	155x39x45 mm - 90g

## GIMATEMP NON CONTACT THERMOMETER

• 25583 GIMATEMP NON CONTACT THERMOMETER GB, FR, IT, ES

• 25584 GIMATEMP NON CONTACT THERMOMETER IT, DE, PT, SE

Multifunctional infrared non contact thermometer with 4 applications: body, liquid, food, ambient temperature.

- high accuracy and quick measurement in ≤2-3 sec
- 3 colour backlight alarm (red, yellow, green) for checking the temperature status
- measuring distance 1-5 cm
- room temperature is always displayed.
- 50 memories

THREE-COLOUR BACKLIGHT ALARM

**NORMAL**  
35.5-37.3°C (95.9-99.1°F)

**SLIGHT FEVER**  
37.4-38.0°C (99.3-100.4°F)

**HIGH FEVER**  
38.1-43.0°C (100.6-109.4°F)



25583

4 APPLICATIONS:  
BODY, LIQUID, FOOD,  
AMBIENT TEMPERATURE



### TECHNICAL SPECIFICATIONS

Measurement method:	Temporal artery scan or forehead spot
Display model - resolution:	°C/°F - 0.1°C/0.1°F
Operating mode:	Adjusted mode (Body mode) Direct mode (Surface mode) Body mode: 34.0-43.0°C/93.2-109.4°F Surface mode: 0-100°C/32-212°F
Output range:	Body mode: 35.0-42.0°C ±0.2°C / 95.0-107.6°F ±0.4°F ±0.3°C/±0.5°F for other range
Accuracy:	Surface mode: ±2°C/±3.6°F
Auto power off time:	≤18 s
Measuring time:	2-3 s
Measuring distance:	1-5 cm (0.4-2 inch)
Batteries (included):	1.5 V (AAA) alkaline batteryX2 (IEC type LR03)
Size - Weight:	122x96x42 mm - 80 g

## INFRARED NON CONTACT THERMOMETERS FOR BODY AND OBJECTS



25591

• 25591 INFRARED NON CONTACT THERMOMETER

Multifunctional infrared non contact thermometer for body and objects.

Effective distance 2.5 cm.

**Body temperature with fever teller**  
Wide range 32.0-42.9 °C (89.6-109 °F)

and green, yellow, red backlight.

**Object temperature 0-100 °C (32-212 °F)**

Body object function for ambient temperature, milk or bath surface temperature.

**Fever alarm**

**32 memories**

**Instant response time: 1 second**

Auto/manual power off.

Supplied with 2AA batteries.

Size 160x95x46 mm.

Display 30x31 mm.

Reading scale °C/°F switchable

Multilingual box and manual: GB, FR, IT, ES.

### FEVER TELLER



Green backlight  
from 32° to 37.5



Yellow backlight  
from 37.6° to 37.9



Red backlight  
from 38° to 42.9°



• 25582 A200 INFRARED NON CONTACT THERMOMETER - GB, FR, IT, ES

• 25590 A200 INFRARED NON CONTACT THERMOMETER - IT, GR, RO, PL

Multifunctional infrared non contact thermometer for body and objects.

Effective distance 2-3 cm.

- result in 1 second

- LCD backlight display

- quality sensor for high accuracy measure

- °C and °F are easily convertible

- 3 colours screen red, orange and green

indicate temperature level

- automatically power off after 30s if left it on still

- 25 groups memories

- audible alarm

- low power warning

Supplied with multilingual box and manual (GB, FR, IT, ES or IT, GR, PL, RO) and batteries.



Green backlight  
< 37.5°C (99.5 °F)

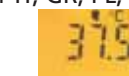

Orange backlight  
≥ 37.5°C ≤ 37.9°C  
(≥99.5°F ≤100.2°F)



Red backlight  
≥ 38.0°C (≥100.4 °F)

Body or  
objects  
switch



25582  
25590

### TECHNICAL SPECIFICATIONS

Measurement Range:	Body 32 - 42.9°C (89.6 - 109.3 °F) ±0.2 °C Objects 0-99°C (32.0-211.82 °F)
Response time:	1 second
Memory:	25 groups
Display Mode:	°C/°F
Battery Type:	2 AAA 1.5V
Dimension (LxWxH) - Weight:	168x54x44 mm - 75 g

## OMRON GENTLE TEMP® 520

### • 25610 OMRON GENTLE TEMP® 520 INFRARED EAR THERMOMETER

Gentle Temp® 520 infrared thermometer offers comfortable, safe, accurate and quick temperature measurement from the eardrum. It offers advanced features: one-second measurement and a memory for up to nine readings to track temperature changes over a period of time and monitor trends. It is intended for home use. Large LCD display. Switchable reading scale °C/°F. It can measure consecutively up to 3 times. Supplied with 1 battery, 21 probe covers, probe cap, connection ring and multilingual instructions (GB, FR, IT, ES, DE, NL, RU, TR, Arabic).



TECHNICAL SPECIFICATIONS	
Measurement range:	34.0-42.2°C (93.2-108.0°F)
Accuracy:	± 0.2°C (± 0.4°F)
Measurement time:	1 second
Temperature mode:	°C/°F switchable
Auto power off time:	1 min
Memory:	9 readings
Display:	LCD display
Battery:	3.0V DC, 1 CR2032 (Gima code 32212) lithium button battery
Battery life:	approx. 2,500 measurements
Size - weight:	161x36x56 mm - 85g
Classification - protection:	Type BF - IP22

## SMARTEMP WIRELESS THERMOMETER

### • 25615 SMARTEMP WIRELESS INFRARED FOREHEAD AND EAR THERMOMETER

Multifunctional infrared thermometer used to read body (ear and forehead) and object temperature.

- clinically accurate, reliable and quick
- professional and home use
- patent technology to separately measure adults and children
- four colour LED backlight
- 10 memory records
- switchable between °C and °F
- audio and visual fever warning
- magnetic probe cover to automatically switch between forehead and ear mode

Wireless connection to mobile devices, downloading free Vihealth App. Supplied with pouch, 2 AAA batteries, multilingual manual: GB, FR, IT, ES, DE.

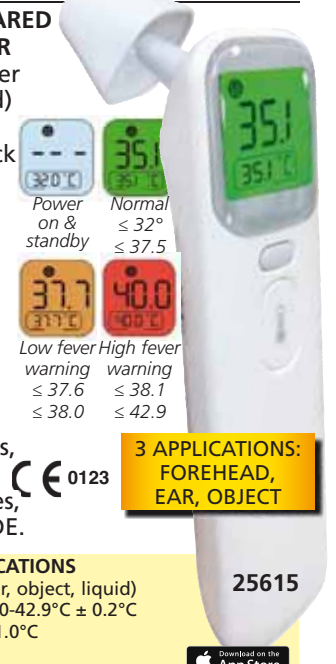

TECHNICAL SPECIFICATIONS	
Measurement type:	3 in 1 (forehead, ear, object, liquid)
Measurement range/accuracy:	forehead & ear 32.0-42.9°C ± 0.2°C object 0 -100°C / ± 1.0°C
Auto power off time:	1 min
Measuring time:	1 second
Temperature mode:	°C/°F switchable
Memory:	10 groups
Display:	LCD, four-colour LED display (white, green, orange, red) Resolution: 0.1 °C/°F
Battery:	3V DC 2xAAA batteries, can be used more than 3000 times
Size - weight:	143x35x41 mm - 80g (with batteries)
Classification - protection:	Type BF - IP22

3 APPLICATIONS: FOREHEAD, EAR, OBJECT

## EAR THERMOMETER

- 25580 IR EAR THERMOMETER
- 25581 PROBE COVERS - box of 40 pcs.
- 32212 SPARE BATTERY

- fully meet "ASTM" standard and CE EN 12470-5 (only few brands passed it) in measurement accuracy (35.5 °C to 42 °C ± 0.2 °C, others ± 0.3 °C).

- unique and handy design
- one-second measurement, fast and easy
- 9 memory for temperature comparison and evaluation, fever alarm, easy reading LCD display
- self-diagnostic and infrared measurement



TECHNICAL SPECIFICATIONS	
Measurement Range:	34.0 °C~42.2 °C (93.2 °F~108.0 °F)
Response time:	1 second
Time between measurements:	> 5 sec
Display Model	°C/°F
Battery Type:	CR2032 (32212)
Dimension (LxWxH) - Weight:	14x3.8x3 cm - 70 g
Norms:	IEC60601-1, IEC60601-1-2 (EMC), ASTM E1965-98

## PROFESSIONAL THERMOMETER

- 25575 PROFESSIONAL INFRARED EAR THERMOMETER
- 25576 PROBE COVERS - box of 200 pcs. (5 tubes of 40 pcs.)
- 25577 PROBE COVERS LOADER with 40 PROBE COVERS

- special design for hospital use

- durable probe for cover replacement up to 100,000 times
- probe cover ejector and probe cover detector
- one-second response time: fast and easy
- neck strap and 1 probe cover included
- fever alarm
- selectable °C/°F

Needs probe covers for use

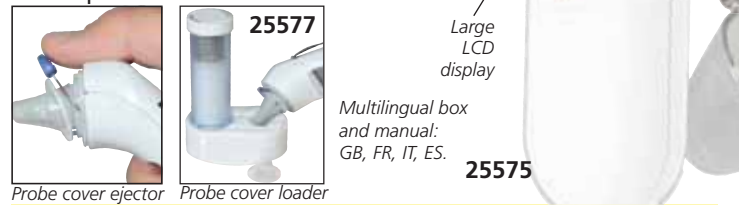

TECHNICAL SPECIFICATIONS	
Measurement range:	34~42.2 °C (93.2-108 °F)
Accuracy:	±0.2 °C (0.4 °F) during 35.5~42 °C (95.9~107.6 °F), ±0.3 °C (0.5 °F) for other range
Memory:	25 sets
Buzzer:	Yes
Battery:	CR2032 1 (Gima code 32212)
Dimension - weight:	144.82x39.84x48.50 mm - 68.8 g

## POCKET EAR THERMOMETER

### • 25579 POCKET EAR THERMOMETER

Small, easy to clean, cover free design ear thermometer. Home use.

TECHNICAL SPECIFICATIONS	
Measurement Range:	34-44 °C (93.2-111.2 °F) - ±0.2 °C (±0.4 °F)
Response time:	1-2 seconds
Battery:	Lithium 3 V (CR2032) - life approx 4,000 measurements
Size - weight:	114x35x40 mm - 35 g (including batteries)



## ECOLOGICAL THERMOMETERS - MERCURY FREE

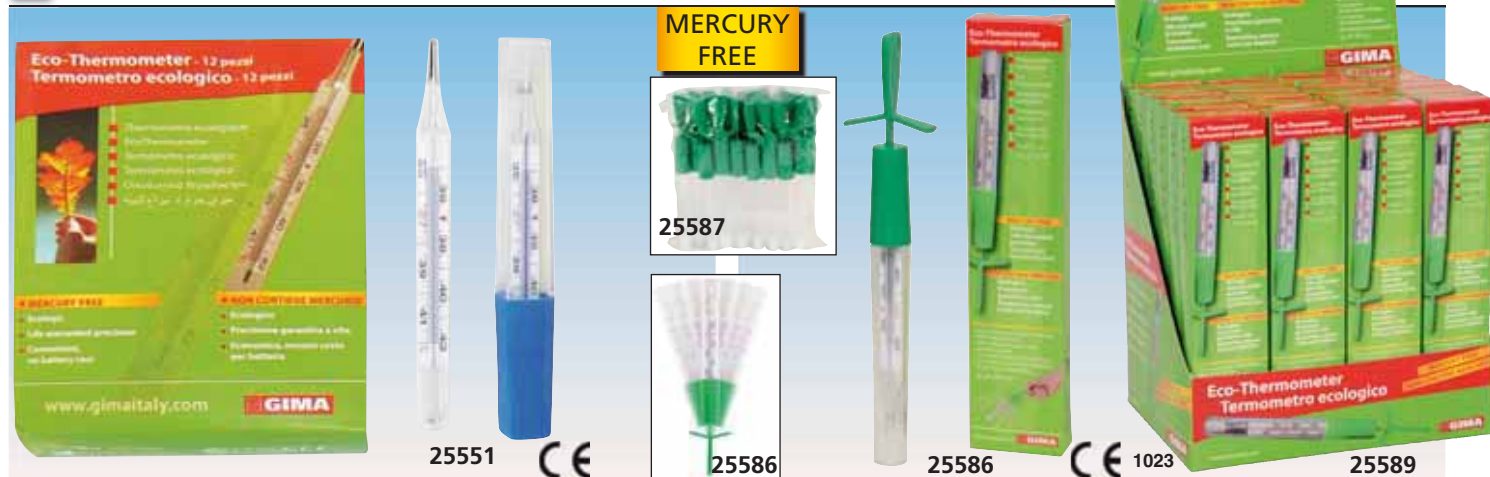

• 25551 ECOLOGICAL OVAL THERMOMETER - box of 12  
 • 25587 SHAKER for ecological thermometers - box of 24  
**Mercury free clinical thermometer with gallium alloy instead of mercury.** Safe, precise and functional. Glass structure. Multilingual box and instructions: GB, FR, IT, ES, PT, DE, PL, RO, SK, GR, Arabic.

• 25586 ECOLOGICAL OVAL THERMOMETER with shaker - box of 1  
 • 25589 ECOLOGICAL OVAL THERMOMETER with shaker - display box of 24 pcs.  
 Same as 25551 but supplied with a shaker to help shake down gallium after use.

## WIRELESS THERMOMETER BLUETOOTH 4.0

• 25548 TEMP SITTER - baby wireless thermometer  
 Accurate and innovative thin thermometer. Transmission to Temp Sitter App (iOS, Android). To be placed under baby armpit. Update frequency every 3 seconds. High temp alarm can be set in the App. Waterproof and material of safe quality. Supplied with 10 adhesives to fix thermometer to baby armpit, manual (GB, FR, IT, ES).

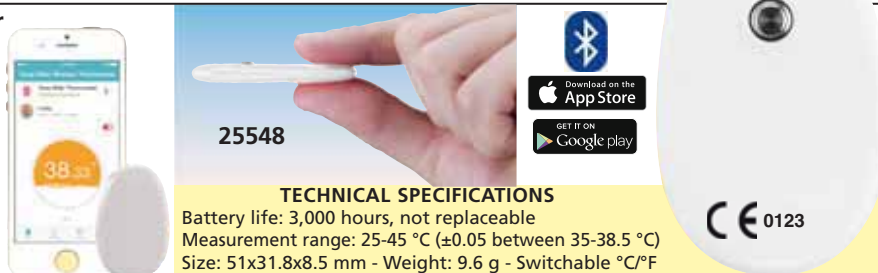

**TECHNICAL SPECIFICATIONS**  
 Battery life: 3,000 hours, not replaceable  
 Measurement range: 25-45 °C (±0.05 between 35-38.5 °C)  
 Size: 51x31.8x8.5 mm - Weight: 9.6 g - Switchable °C/°F

## OMRON DIGITAL THERMOMETERS

- 25603 ECO TEMP BASIC THERMOMETER - MC 246-E
- 25604 FLEX TEMP SMART THERMOMETER - MC 343F-E



	TECHNICAL SPECIFICATIONS	
Model	25603 (Eco Basic)	25604 (Flex Smart)
Measurement Type	Oral, Armpit, Rectal	Oral, Armpit, Rectal
Flexible tip		•
Beeper (signals when a measurement is complete)	•	•
Memory	last reading	last reading
°C/°F selection	•	•
Large, 3 digit display	•	•
Water resistant	•	•
Automatic shut off	•	•

## LIQUID CRYSTAL FOREHEAD THERMOMETERS

- 25599 FEVERTEST - bag of 10 blister
- 25596 FEVERTEST BULK - box of 100 - hospital use
- 25600 FEVERCONTROL - bag of 10 blister

Reusable, non toxic, mercury free, safe, unbreakable, reliable, long lasting, easy to read, liquid crystal thermometers. They indicate temperature in 15 sec with graduation 0.5°C. Medical Devices.



25599  
101

25600



25596

Instructions: GB, FR, IT, ES, DE, RU.

## 48h FEVERMONITOR

- 25601 48h FEVER MONITOR - bag of 10 blister of 3 pcs.

Innovative "continual" fever indicator for 48h monitoring, for babies. Disposable, non toxic, mercury free, safe, unbreakable, reliable, easy to read, liquid crystal thermometers. It indicates temperature in 30 seconds. Medical Device.



25601



Blister in GB, IT  
CE 0051

## DIGITAL THERMOMETERS

60 SECONDS



25564

- 25564 GIMA VALUE DIGITAL THERMOMETER °C - box - rigid tip

30-60 SECONDS CE 0197



25559-60-65

- 25559 GIMA DIGITAL THERMOMETER °C - box - 30 seconds
- Sold in a counter display of 36 pcs. (GB - IT)
- 25560 GIMA DIGITAL THERMOMETER °C - hang box - 60 seconds - GB, FR, IT, ES, PT, DE, GR, Arabic.
- 25565 GIMA DIGITAL THERMOMETER °C - hang box - 60 seconds - GB, IT, PL, SE, FI, CZ, RO, HR.
- 25561 GIMA DIGITAL THERMOMETER °F - hang box - 60 seconds (89,6-107,6 °F) - GB, FR, IT, ES, PT, DE, GR, Arabic.

60 SECONDS CE 0197



- 25557 FLEXI JUMBO 2 DIGITAL THERMOMETER °C - hang box, flexible tip, water-proof resistant, fever alarm

30 SECONDS CE 0476



- 25562 W-P DIGITAL THERMOMETER °C - hang box water-proof

30 SECONDS CE 0476



- 25563 FLEXI DIGITAL THERMOMETER °C - hang box flexible tip, water-proof

22 SECONDS



25552

- 25552 WIDE SCREEN DIGITAL THERMOMETER - box flexible tip, large display 27x22 mm. Battery 1.5 V button size

10 SECONDS BACKLIGHT



25553

- 25553 BL1 WIDE SCREEN DIGITAL THERMOMETER - box flexible tip, water-proof, backlight after measurement, wide display (27x22 mm). Battery 3 V button size. Low battery indicator.

## BABY THERMOMETER

30 SECONDS CE 0476 Multilingual box and manual: GB, FR, IT, ES.



- 25544 FROG DIGITAL THERMOMETER °C - hang box - flexible tip. Display range 32-42.9 °C (90.0-109.9°F)



Counter display of 36 pieces 25559

### GIMA DIGITAL THERMOMETERS

- Available in °C or °F, provide accurate and quick read-out.
- Safe and easy to use with clear and large display.
- display range: 32.0-42.9°C (25556-7, 25559-60, 25562-5, 25552-4) 32.0-42.0°C (25558)
- accuracy ±0.1°C (±0.2°F)
- beeper function and auto shut-off
- memory: last reading
- plastic case
- multilingual manual and box (GB, FR, IT, ES, PT, GR) 25556, 25557, 25558 have also PL, Arabic. See beside for 25560/61/65
- 25549 BATTERY 1.5 V LR/41 - box of 20 for all thermometers except 25558, 25553, 25554

10 SECONDS CE 0197 FDA



- 25558 FLEXI JUMBO DIGITAL THERMOMETER °C/°F (switchable) - hang box, flexible tip, water-proof, fever alarm, backlight jumbo display (27.5x12 mm). Battery CR1632. Rectal/oral use.

8 SECONDS CE 0197



- 25556 INSTANT DIGITAL THERMOMETER °C/°F (switchable) - hang box, flexible tip, water-proof, fever alarm, large display

20 SECONDS GREEN/ORANGE/RED BACKLIGHT



Lower than 37.1 °C will show green. Between 37.2 and 37.9 °C will show orange. Between 38.0 °C and 43.0 °C will show red mean fever



Battery 3 V button size (CR2032)

- 25554 BL3 WIDE SCREEN DIGITAL THERMOMETER - blister flexible tip, water-proof, red/orange/green backlight after measurement, wide display 29.3x15.3 mm. Low battery indicator

## BASAL THERMOMETER

- 25608 DIGITAL BASAL THERMOMETER °C - hang box - water-proof With 4 digits, 2 decimals, for fertility control. Multilingual box and manual: GB, FR, IT, ES, PT, DE, GR, FI, RO, Arabic.

4 DIGITS, 2 DECIMALS



25608

## QUALITY PILL SPLITTERS AND PILL PULVERIZERS

These easy tools are ideal for elderly people, children and hospital attendants. Useful also for medicating pets. They avoid dispersion of medicine and guarantee integrity of the dose. Easy to clean, also in dishwasher. Made of non-toxic, unbreakable material.

- 25729 PILL SPLITTER - bulk
- 25730 PILL SPLITTER - with box
- 25743 ULTRA PILL SPLITTER - blister

Accurately divide tablets, large and small pills for reduced dosage or easier ingestion. Simple to operate. Top quality products, made in Europe (25729-30), USA (25743)

- 25747 DISPLAY FOR SPLITTER (25730) PULVERIZER (25731) - empty (English language)

Suitable for 4 pill splitters and 4 pill pulverizers. Available in any language on request.

- 25731 PILL PULVERIZER - with box
- 25738 CRUSH PILL PULVERIZER - blister

Powerful pulverizing point, powders pills of any shape and size, with an easy twist of the wrist.

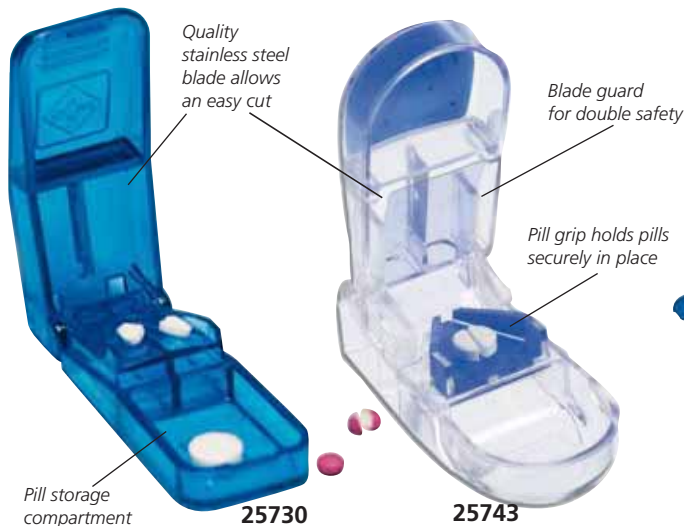

Multilingual box and instructions:  
GB, FR, IT, ES, DE, PT, PL, GR (25730, 25731)  
GB, IT, ES (25743)  
GB, FR, IT, ES (25738)

## MIXED COLOURS PILL SPLITTERS - BOX OR DISPLAY



- 25736 PILL SPLITTER - box of 12 pcs

This box includes 12 pill splitters in 4 colours: light blue, white, transparent lavender and transparent orange.

- 25737 PILL SPLITTER - display box of 12 pcs
- Counter display box including 12 pill splitters in 4 colours (light blue, white, transparent lavender and transparent orange) in a single cardboard box.



## COMBO SPLITTER-CRUSHER PILL BOX TIMER



- 25766 COMBO PILL MANAGER 4 IN 1
- Four functions in a practical device: pill splitter, pill crusher, pill box and water cup.

25766

## PILL BOX TIMER

- 25765 PILL BOX TIMER

Pocket pill box timer in ABS material, size 90x50x19 mm, supplied in cardboard box with batteries.

Double pill box space to store pills and tablets. It reminds when you have to take your medication with a countdown up to 19 hours and 59 minutes.



25765



## VIALS OPENER

- 25739 VIALS OPENER - box of 20
- A practical tool to help opening vials in a safe way.



25739

# PILL BOXES: 7 DAYS AND SINGLE DAY PLANNERS

- 25751 7-DAY TOWER PLANNER - GB, FR
- 25753 7-DAY TOWER PLANNER - IT, DE
- 25755 7-DAY TOWER PLANNER - ES, PT

Available in any other language minimum 2,000 pcs (available in 90 days).



7 detachable 4-compartment boxes (morning, noon, evening, night) Size: 10.5x3.5x1.5 cm

25751



Size: 13x11x3.5 cm

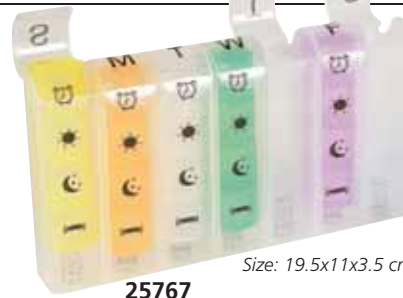

25767

Size: 19.5x11x3.5 cm



7 detachable 4-compartment boxes Size: 9x2xh 2.5 cm

- 25767 7-DAY SPRING PLANNER x4 - GB
  - 25768 7-DAY SPRING PLANNER x4 - FR
  - 25769 7-DAY SPRING PLANNER x4 - IT
- Available in any language min 2,000 pcs (available in 90 days). All spring planners have braille in English.

- 25732 - 7 DAYS PILL BOX blue translucent

Translucent top enables the user to see if medication has been taken

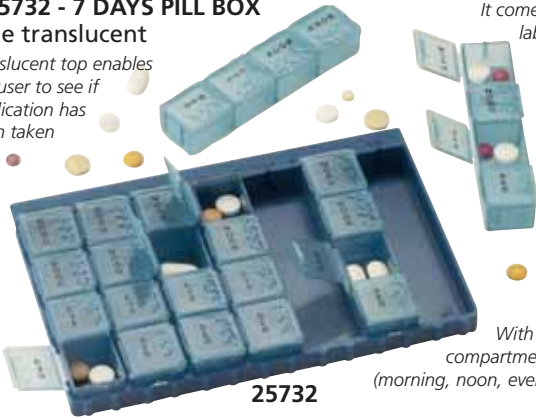

25732

It comes with one set of labels for individual marking of compartments in 11 languages (GB, FR, IT, ES, DE, PT, PL, GR, HU, RO, SE)

With 7 detachable 4 compartments small boxes (morning, noon, evening and night)



25761

Size: 18x11.5x2.5 cm



- 25761 7-DAY EASY PLANNER x4 - GB
  - 25762 7-DAY EASY PLANNER x4 - FR
  - 25763 7-DAY EASY PLANNER x4 - IT
  - 25764 7-DAY EASY PLANNER x4 - ES
- Available in any other language minimum 2,000 pcs (available in 90 days).

7 detachable 4-compartment boxes (morning, noon, evening, night) Size: 10x2.5xh 2 cm

- 41500 7-DAY PILL PLANNER x2 - GB
  - 41501 7-DAY PILL PLANNER x2 - IT
- 2 translucent colours. Size 18.3x9.3x3.3 cm.

14 compartments

Pill planners available in other languages, minimum 2,000 pcs (availability 120 days)



41501

2 pill compartments for each day of the week (morning and afternoon) with colour codes



41500

- 41505 7-DAY PILL PLANNER x4 - GB
  - 41506 7-DAY PILL PLANNER x4 - IT
- 4 translucent colours. Size 19x13x2.8 cm.

Pill clearly visible through transparent lids

28 compartments for weekly use (morning, moon, evening and bed time)



41505

Contoured design for easy pill removal

41506



Holds up to 50 pills



25750

25752



25735



25741



25734 is supplied with a set of labels suitable for 6 languages (GB, FR, DE, IT, ES, PT) for marking compartment. 1 additional white label for personalization.



25734



25831

25832

25833



25830

- 25750 DAILY PILL BOX pack of 2 pcs - blue/pink - pouch - GB
- 25735 DAILY PILL BOX - yellow - box - GB, FR, IT, ES, PT, DE, PL, SE, GR, Arabic
- 25752 DAILY PILL BOX - blue translucent - blister
- 25741 DAILY PILL BOX - white - transparent - hanging pouch

- 25734 WEEKLY PILL BOX - white - box
- 25830 WEEKLY PILL BOX - transparent - hang box - GB
- 25831 WEEKLY PILL BOX - transparent - hang box - FR, ES, RO
- 25832 WEEKLY PILL BOX - transparent - hang box - IT
- 25833 WEEKLY PILL BOX - transparent - hang box - SE, DK, NO

	DAILY				WEEKLY							
	25750	25741	25752	25735	25734	25830, 25833	41500, 41501	25732	25751, 25753, 25755	25761, 25764	25767, 25769	41505, 41506
Compartments	2	4	6	6	7	7	14 (2x7)	28 (4x7)	28 (4x7)	28 (4x7)	28 (4x7)	28 (4x7)
Translucent	yes	yes	yes	no	no	yes	yes	yes	yes	yes	yes	yes
Size (cm)	7x5x2	10.5x3.5x1.5	8x5.5x1.5	8x5.5x1.5	13x2.5x2	14.5x3x2	18.3x9.3x3.3	17x12x2	13x11x3.5	18x11.5x2.5	19.5x11x3.5	19x13x2.8
Package	pouch	pouch	blister	box	box	box	box	box	box	box	box	box

## □ PILL CRUSHING DEVICE

- **25872 SILENT KNIGHT HOSPITAL PILL CRUSHING DEVICE**
  - **25873 PILL CRUSHER POUCHES - 1,000 pouches (20 packs of 50)**
- Professional, silent crusher for hospital to effortlessly and easily reduce pills in fine powder in few-seconds. Pouches avoid any cross contamination and eliminate loss of medication. Silent Knight is supplied with 50 pouches.

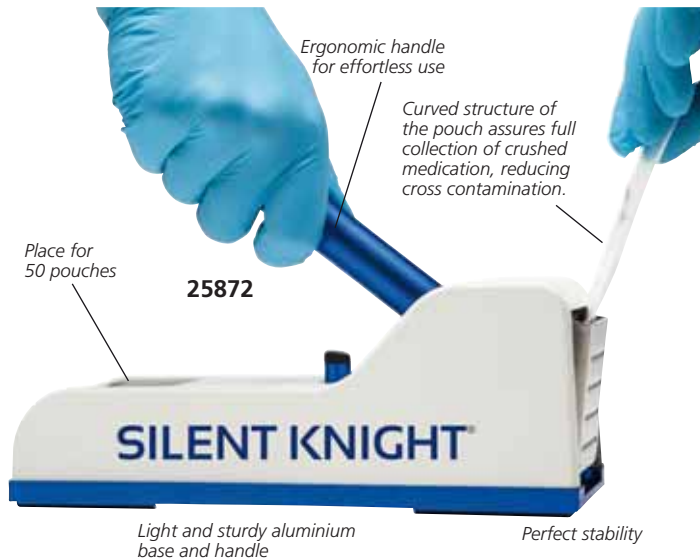

- Step 1:** place pills into pill crusher pouch.  
**Step 2:** press handle down to crush pills.  
**Step 3:** press the handle down to activate grinding movement. Press handle down several times to grind pills into fine powder.  
**Step 4:** remove the pouch.

## □ ELECTRIC PILL GRINDER

- **25850 SEVERO ELECTRIC PILL GRINDER**
- Professional silent pill grinder for fast and effective crushing of medication in hospitals, nursing homes and home care organizations. It avoids exposure to dust or cross contamination. The device works through autonomous grinding cycles via combined compression and rotation, through which it is possible to grind multiple standard pills and coated pills per cycle. Once the medicine is put into the 30 ml special cup, it takes only 8 seconds (for regular pills) to obtain it as powder. Pulverized pills are ideal for people who have trouble swallowing pills or to be administered via feeding tubes. Supplied with stainless steel grinding head, 30 cups, 30 cellophane grinding sheets, AC/DC adapter and GB, FR, IT, PT manual. Available DE, NL on [www.gimaitaly.com](http://www.gimaitaly.com).



**FROM PILL TO POWDER  
IN FEW SECONDS**

TECHNICAL SPECIFICATIONS	
Cup volume:	30 ml
Grinding cycle time:	8 seconds for regular pills
Sound level:	52dB
Battery:	rechargeable lithium-ion, 12 V 3 Ah
Battery last:	500 crushing's (three days of continuous working)
Charging time:	2 hours
Size - weight:	80x70x217 mm - 1.5 kg



- **25851 SEVERO MEDICINE CUPS - box of 2100**
  - **25852 SEVERO CUP LIDS - box of 2000**
  - **25853 SEVERO CELLOPHANE GRINDING SHEETS - box of 2100**
  - **25854 SEVERO MAGNETIC STABILITY PLATE**
- Powder coated metal plate and magnetic sticker to be inserted underneath to stabilize Severo on medication trolleys.

## □ PILL DISPENSER - WIRELESS

- **25871 WIRELESS PILL DISPENSER**
- Automatic wireless pill dispenser to manage and record pills' dosage data with Healbox App and cloud server. It lets patients and caregivers to program dosages up to a maximum of 28 consecutive days. It also allows to give right dose to right patients at right time. The device has audio and visual alerts up to 9 alarms per day, which sound for 30 minutes or until the dispenser is flipped. It automatically rotates when it's time for the next dose. 28 compartments with 24 aspirin sized pills load capacity. Lid can be locked with metal key.
- For hospital, community service or personal use. Supplied with 1 medication tray, 1 set of dosage rings, 1 metal key, 4xAA batteries and multilingual instructions (GB, FR, IT, ES, PT)

TECHNICAL SPECIFICATIONS			
Compartments:	28 slots	Connection:	10 meters limited range
Capacity:	24 Aspirin-sized pills	Battery:	4xAA batteries
Material:	ABS	Size:	225x h 68 mm
LED display size:	60x30 mm	Weight:	600 g



## □ GRASPING TOOLS

- **28960 GRASPING TOOL - 3 WAYS - 66 cm**
- Aluminium body, PP handle. Three grasping ways: steel hook, magnetic tip, rubber head.

- **28963 GRASPING TOOL - foldable**
- Extended reach grasping tool helps to eliminate bending or climbing for hard-to-reach items. Length: 80 cm, foldable in 2. Locking tab holds the item in place.

# EASY LIFE: AIDS FOR DAILY LIVING



• **28920 CUTLERY SET**  
 • **28921 BENDABLE CUTLERY SET**  
 Set of 4 pieces (knife, fork, tea and table spoon). Made of stainless steel with thick, ribbed rubber handle (11 cm) for easy grip



• **28925 SPOON & FORK HOLDERS - pack of 2 pcs.**  
 These portable, stylish holders fit onto virtually any style spoon and fork providing a secure grip (spoon and fork are not included).



• **28966 DRINKING GLASS - box of 210**  
 Drinking glass made of polypropylene with a separated tap and a lip. Capacity 250 ml graduated by 25 ml. Autoclavable. Dishwasher safe. Not for microwaves.



Capacity: 295 ml - Diameter: 7.60 cm (3")  
 Height: 12.7 cm (5") - Weight: 0.27 kg

• **28967 HANDLE GRIP CUP**  
 Transparent plastic resistant mug with two large handles to allow a more secure grip. Extra-wide base for stability and to reduce tipping over. It includes a spouted lid with a little hole for straws. Suitable for patients with limited hand control and tremors. Mug only is dishwasher and microwave safe.

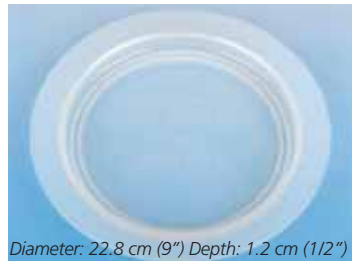

Diameter: 22.8 cm (9") Depth: 1.2 cm (1/2")

• **28930 INNER LIP PLATE**  
 High rim around the entire plate to keep food from sliding off and prevent food spills. Raised lip facilitates the grasping of food with fork or spoon. Made of durable transparent plastic, which is dishwasher and microwave safe.

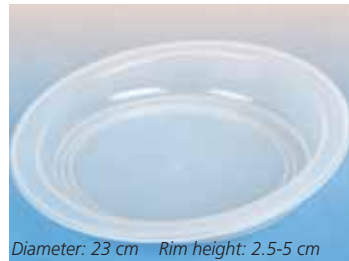

Diameter: 23 cm Rim height: 2.5-5 cm

• **28931 HIGH RIM PLATE**  
 Polypropylene high rim plate with one side higher than the other to allow one-handed eating. Higher side facilitates the grasping of food with one hand without spilling it. Heat-resistant: 100-120°C Cooling resistant temperature: -20°C



Diameter: 22.8 cm (9")

• **28932 3-SECTION PLATE**  
 Plastic plate divided in 3 sections to keep food separate. It helps patients with physical disabilities, tremors, Parkinson...to eat independently. Made of resistant plastic.



Diameter: 22.8 cm (9")

• **28935 SUCTION PAD for plates**  
 White anti-slip suction pad with patented vacuum system to be attached on flat surface with slight pressure. It holds plate in place allowing patients with disease, which restrict hand movement, to eat and drink independently and reduce accidental spills.

Multilingual box and instructions: GB, FR, IT, ES, PT, DE, GR, Arabic.



• **28915 LONG BATH SPONGE**  
 Lightweight sponge features soft polyfoam attached to a plastic handle. Available with contoured sponge.



28951

• **28951 JAR OPENER & CLOSER**  
 This uniquely designed product concentrates hand power to remove lids and turn facets effortlessly.



• **28950 EASY OPENER**  
 All in one product easily opens bottle caps, pull tabs and even impossible box tops! Designed to provide safety for the user.



• **28906 MAGNIFYING GLASS**  
 Magnifies two times larger than original size. Large enough to do what's needed. Small, portable, fitting easily into purse or pocket.



Can hold 1 to 3 keys. Keys fold into handle when not in use to slip into pocket or purse.

Length 13 cm

• **28941 MULTIPLE KEY TURNER**  
 Designed to assist people with limited wrist strength or movement (arthritis or other limited hand mobility) to manipulate keys with ease. House keys and most car keys (without plastic head covers) fit into the slots and are held by a single screw.

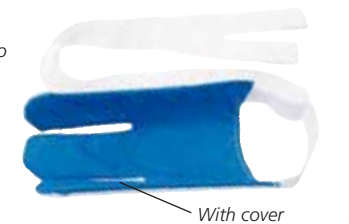

With cover

• **28912 SOCK AID NOTCH**  
 Soft terry cloth side grips the sock, while smooth nylon side reduces friction, allowing foot to slip in easily. Two long loop handles are easy to hold and assist with pulling the sock onto foot. Ideal for people who can use one hand only or with decreased strength or coordination.



28911

• **28911 ZIPPER AND BUTTON PULLER**  
 It helps pulling the button or zipper into position. Folds to half-length to fit easily into pocket or purse. Ideal for people with weak or arthritic fingers.



• **28945 SHOPPING BAG CARRIER**  
 This product provides an effort-free handle that remains constantly supportive, regardless of bag loads.

# PHARMADOCT FIRST AID, MEDICATION AND WELLNESS



All products are in blister with 7 languages package (GB, FR, IT, ES, DE, PT, GR) except 25332, 25370, 25380/82/90 (only GB, FR, IT, ES, DE)

GIMA code	PHARMADOCT LINE	Pieces per box	Minimum order*	GIMA code	PHARMADOCT LINE	Pieces per box	Minimum order*
25300	Classic plasters - 7x2 cm	20	12 box	25316	Herpes patch	15	12 box
25301	Classic plasters - 5 assorted sizes**	30	12 box	25318	Nasal strips	10	12 box
25302	Classic plasters - 6 assorted sizes***	100	12 box	25372	Ear plugs	4	12 box
25305	Hypoallergenic plasters - 5 assorted sizes**	30	12 box	25350	Corn plasters	10	12 box
25307	Hypoallergenic plasters - 2 (7.5x7.5), 2 (7.5x10)	4	12 box	25351	Oval corn plasters	9	12 box
25310	Children plasters "tattoo" 10 (6x2), 6 (7x3.8)	16	12 box	25352	Blister plasters	5	12 box
25312	Plasters with hemostatic gauze	20	12 box	25370	Dental floss	1	12 box
25314	Hand plasters - 5 (12x2), 5 (7x2), 4 (butterfly)	14	12 box	25380	Lip balm classic	1	12 box
25320	Dressing strip 100x6 cm	1	12 box	25382	Lip balm strawberry	1	12 box
25322	Cloth roll - fabric - 5 mx1.25 cm	1	18 box	25360	Nail scissors	1	12 box
25324	Cloth roll 5 mx2.5 cm	1	12 box	25361	Cuticle clipper	1	12 box
25335	First aid - kit of 8 different products	8	8 box	25362	Nail file	1	12 box
25330	Cotton gauze swabs 18x40 cm	6	12 box	25363	Tweezer	1	12 box
25332	Elastic bandages 4 mx6 cm	2	6 box	25364	Small nail cutter	1	12 box
25337	Adhesive elastic compression bandage 2.5 m x 6 cm	1	6 box	25390	Condoms	12	8 box

\*Minimum order is carton of "X" boxes, each one containing "Y" pieces \*\*10 (7x2), 10 (4x1), 2 (3.8x3.8), 4 (7x2.4), 4 (Ø 2.5)

\*\*\*30 (7x2), 20 (4x1), 20 (7x2.4), 10 (Ø 2.5), 14 (6x2), 6 (3.8x3.8)

Graphic of Pharmadoc line boxes are subject to changes

## V-FOLD, W-FOLD AND Z-FOLD HAND TOWELS

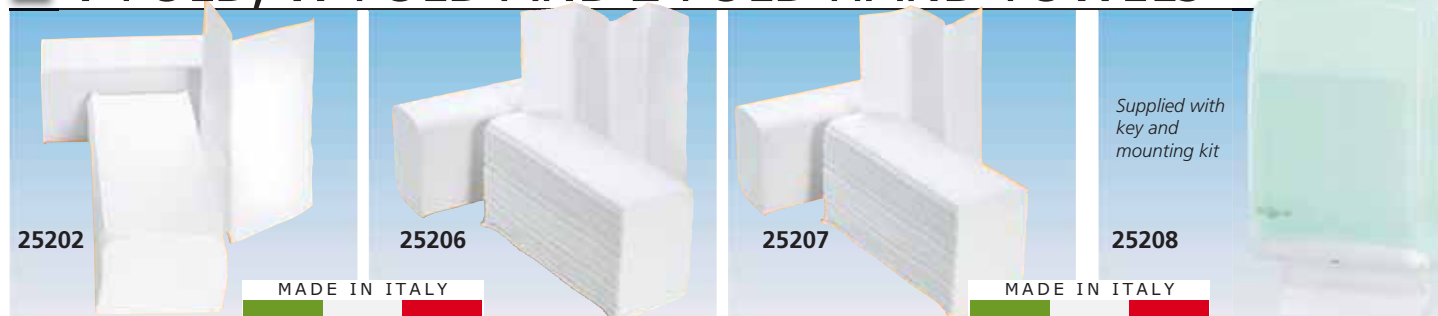

### HAND TOWELS AND DISPENSER

GIMA code	Model	Material	Weight	Size cm		Minimum order
				Open	Folded	
25202	V-Fold hand towels - 2 plies	recycled paper	37g/m <sup>2</sup> : 2x18.5 g/m <sup>2</sup>	25x23	25x11.5	20 packs of 160
25206	W-Fold hand towels - 2 plies	pure cellulose	37g/m <sup>2</sup> : 2x18.5 g/m <sup>2</sup>	24x32	24x8	15 packs of 124
25207	Z-Fold hand towels - 2 plies	pure cellulose	37g/m <sup>2</sup> : 2x18.5 g/m <sup>2</sup>	24x24	24x8	15 packs of 166
25208	Dispenser for V, W, Z-Fold hand towels	PP with Masterbio	0.8 kg	30.5x41.5x15.5		-

## ABSORBENT NON WOVEN WIPES



Non woven absorbent wipes for sanitary, health and hygienic use. Made of wood pulp, PES, spunbonded PP.

GIMA code	ABSORBENT NON WOVEN WIPES			Minimum order
	Model	Size cm*	Weight g	
25222	Smooth - folded	30x40	45-50	1.400 pcs**

\*Size accuracy: ±5% \*\*28 boxes of 50

## HAND TOWELS ROLLS



## FOLDED NAPKINS

### FOLDED NAPKINS

Pre-coated folded napkins, made of 2 plies of pure cellulose wadding laminated with 1 ply of polyethylene or 1 ply of pure cellulose wadding laminated with 1 ply of polyethylene. High absorbency and waterproofness to assure high comfort.

GIMA code	FOLDED NAPKINS - pack of 500 pcs		
	Napkins 2+1 (2 plies cellulose + 1 ply polyethylene)		
25230	Napkins 33x45 cm	- green	
25231	Napkins 33x45 cm	- light blue	
25232	Napkins 33x45 cm	- pink	
25233	Napkins 33x45 cm	- white	
Napkins 1+1 (1 ply cellulose + 1 ply polyethylene)			
25226	Napkins 33x45 cm	- blue	
25227	Napkins 33x45 cm	- lilac	
25228	Napkins 33x45 cm	- orange	
25240	Plastic dispenser		
25239	Chain for napkins		



## INVALID RINGS



Quality invalid rings made of rubber. Internal hole Ø 14 cm.



28614

GIMA code	INVALID RUBBER RINGS
28610	Invalid ring Ø 35 cm
28611	Invalid ring Ø 40 cm
28612	Invalid ring Ø 45 cm
28614	Pump for invalid ring

## BIBS

25672 BIBS 50x60 cm - box of 6 rolls of 80 bibs

Made of 2 plies, one of highly absorbent cellulose tissue and one of waterproof polyethylene. Extremely soft and comfortable, they assure an excellent protection to the patient. Each roll has 80 bibs with pre-cut and comfortable ribbons or bi-adhesive.

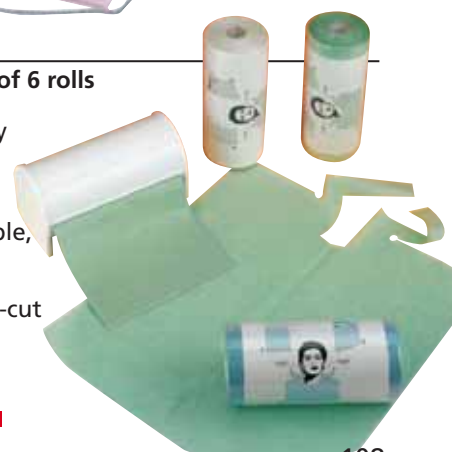

MADE IN ITALY

## TRAVELJOHN™ RESEALABLE DISPOSABLE URINAL AND VOMIT BAG



**TRAVELJOHN™ DISPOSABLE URINAL AND VOMIT BAG**  
 Disposable personal urinal or vomit (only 25887) bag for men, women and children.  
 Each bag contains a pouch filled with LIQSORB®, a unique polymer substance that absorbs liquid waste and turns it instantly into odourless spill-proof gel.  
 The peel and seal closure (25879, 25887) or air-tight closure (25880) ensure complete odour control. Reusable until it is full, can be simply thrown as normal waste.  
 2 in 1 design for vomit or urination use (only 25887).

GIMA code	TRAVELJOHN™ DISPOSABLE BAGS	Unisex adapter	Minimum order
25879	Paper urinal bag 800 cc	flexible	box of 4
25880	Plastic urinal bag 800 cc	rigid	box of 3
25887	Paper urinal and vomit bag 800 cc	-	box of 5

## SOFFISOF INCONTINENCE PADS

**SOFFISOF CLASSIC AND AIR DRY INCONTINENCE PADS - LATEX FREE**  
 Anatomically shaped absorbent diapers with repositionable fastening tapes. Made of fluff of pure cellulose (100% PEFC certified), superabsorbent polymers and waterproof exterior layer. They ensure maximum safety in case of moderate or

high incontinence level. Hypoallergenic, dermo protective with odour control. The new design guarantees maximum comfort. Gradual fade wetness indicator easily suggests when it's time for a change. Air Dry pads have a special breathable outer layer that helps to reduce the onset of redness and irritations.

Multilingual package:  
 GB, FR, IT, ES,  
 DE, PT, Arabic.

Multilingual package:  
 GB, FR, IT, ES,  
 DE, PT, Arabic.



Medium	Large	XX-Large	SOFFISOF CLASSIC	Minimum order
Circumference (cm)				
70-110	100-150	155-175		
36701	36702	-	Moderate incontinence-day	box of 90*
36704	36705	36706	Heavy incontinence-night	box of 60**

\*6 boxes of 15 \*\*4 boxes of 15

Medium	Large	XX-Large	SOFFISOF AIR DRY	Minimum order
Circumference (cm)				
70-110	100-150	155-175		
36707	36708	-	Moderate incontinence-day	box of 90*
36710	36711	36712	Heavy incontinence-night	box of 60**

\*6 boxes of 15 \*\*4 boxes of 15

## SOFFISOF INCONTINENCE AIR DRY PANTS PULL-UP

**SOFFISOF AIR DRY PANTS/PULL-UP - LATEX FREE**  
 Disposable absorbent panty ideal for walking, self-sufficient and active patients, with slight to severe leakages. Air dry, hypoallergenic, dermo protective with odour control. Outer lining in soft breathable fabric allows skin to breathe. Ergonomic elastic band for maximum comfort and greater fit. Soft elastic and thigh line barriers ensure maximum leak protection. Gradual fade wetness indicator easily suggests panty change.



Medium	Large	X-Large	SOFFISOF PANTS/PULL-UP	Minimum order
Circumference (cm)				
70-110	110-150	135-160		
36715	36716	-	Moderate incontinence-day	box of 84*
-	-	36717	Moderate incontinence-day	box of 48**
36718	36719	-	Heavy incontinence-night	box of 32***

\*6 boxes of 14 \*\*4 boxes of 12 \*\*\*4 boxes of 8

## SOFFISOF ABSORBENT BED PADS

**SOFFISOF ABSORBENT BED PADS - LATEX FREE**  
 Absorbent bed pads ideal for protecting beds, mattresses, armchairs and chairs. The layer in contact with the skin is made of soft non-woven fabric, inner mattress in superabsorbent fluff of pure cellulose and the outer side is in polyethylene, an excellent barrier against liquids. Larger size (36721, 36725) has foldable side flaps tuckable under the mattress to ensure maximum protection.



GIMA code	SOFFISOF ABSORBENT BED PADS	Size	Minimum order
<b>CLASSIC LINE</b>			
36720	Heavy incontinence	60x90 cm	box of 90*
36721	Heavy incontinence	80x180 cm	box of 90*
<b>IDEALITE LINE</b>			
36724	Moderate incontinence	60x90 cm	box of 120**
36725	Moderate incontinence	80x180 cm	box of 120**

\*6 boxes of 15 \*\*4 boxes of 30

## BIBS WITH POCKET

Size: 37x67 cm  
+ 10 cm (pocket)

Extremely soft and comfortable

Large pocket

36666

Easy fastening on patient by laces

- **36666 BIBS WITH POCKET - box of 600** Disposable bibs made of 1 ply of highly absorbent wadding of cellulose and 1 ply of waterproof blue polyethylene. Box of 600 (6 bags of 100).

## PATIENT ANTI-HANDLING SUIT

PATIENT ANTI-HANDLING SUIT

The suit prevents the patient from handling himself during night or day. The zip allows the operator to intervene easily on the patient, for hygiene. Back closure with double slider zip and final reinforcement. Long sleeves with soft elastic at the cuffs and bottom of the leg; double reinforced crotch. Made of 100% polyester honeycomb stretch weft. Resistant to washing with chlorine at 38°C and in water with detergent at 90°C. Weight: gr/m<sup>2</sup> 200 ±5%. Quick drying and thermoregulating.

>100\* WASHES

\*Resistant to washing with chlorine at 38°C and in water with detergent at 90°C

MADE IN ITALY

PATIENT ANTI-HANDLING SUIT	
GIMA code	Unisex - green
36730	Anti-handling suit - S
36731	Anti-handling suit - M
36732	Anti-handling suit - L
36733	Anti-handling suit - XL



Front



Back

## SOAPED SPONGE, SOAPED AND NON SOAPED WASH GLOVE



36659

- **36659 SOAPED SPONGE - box of 100** Disposable sponge in foam soaked with anallergenic, neutral PH soap. Ideal for patient cleaning and hygiene. Individually packed. Size: 7.5x12xh 2.5 cm.



36663

- **36663 SOAPED WASH GLOVE - box of 50** Disposable mitten to wash patient. Made of non woven and sponge, soaked with liquid soap with neutral PH and anallergenic. Ideal for patient cleaning and hygiene. Size: 15x25 cm.



36661

MADE IN ITALY

- **36661 WASH GLOVE - box of 1,000 (20 bags of 50)** Disposable wash glove to clean patients. Made of soft curacell, which allows to gently soap and rinse patient, and waterproof PE. Embossed surface allows a deep cleaning. Size: 16.5x22 cm.

## SKIN SOAP

- **36671 FRAGRANCE SKIN SOAP - 1,000 ml** Delicate, skin protective, fragrance soothing bath and shower with moisturizer active agents. It respects the lipid mantle and it is delicate on skin, leaving it fresh and pleasantly soft. It is used for daily personal hygiene as a normal liquid soap, bath, shower and shampoo. Suitable for frequent washing, it protects and soothes sensitive skin of children and elderly people. Fast to be rinsed, it leaves a fresh cleanness sensation.



36671

MADE IN ITALY

- **36692 DISPENSER PUMP - optional**

## GERMELLA

- **36672 GERMELLA - 1,000 ml** Germella is a skin-protecting liquid detergent combining the properties of three extraordinary medical plants: **Camomile, Sage and Aloe**. Camomile and Sage have moisturizing and soothing qualities. Aloe Vera has soothing property and makes your skin soft and velvety. Germella is a delicate detergent, which respects the natural defence of skin and mucous membranes. Its natural ingredients make it also suitable for daily intimate care.



36672

MADE IN ITALY

- **36692 DISPENSER PUMP - optional**

## SEPTI SAVON

- **36674 SEPTI SAVON - 250 ml - box of 12** Septi Savon is a 5.5 pH soap with antibacterial agents that prevents and eliminates unpleasant odours. The presence of orthophenylphenol and Benzalkonium chloride guarantees a sanitizing and antibacterial action. Delicate on the skin, it can be used for total body shower and for children.



36674

- Its neutral formula, enriched by glycerine, helps to maintain normal equilibrium of skin and prevents dehydration even after repeated washing.

MADE IN ITALY

## DOSASOAP NO-TOUCH HAND-WASH SYSTEM

- **36677 DOSASOAP NO-TOUCH HAND WASH SYSTEM - white** Dosasoap is a no-touch dispenser for antiseptics, convenient for detergents, liquid soaps and gels. Equipped with sensor that detects hand movements, it dispenses the product in a comfortable way. Dosasoap ensures a rapid and safe hand hygiene, without any contact with the dispenser and unnecessary waste. Suitable for use with 1 litre bottles (36671, 36672).

36677



36678

- **36678 PUMP FOR DOSASOAP - spare**



1 litre bottle

Dosasoap

# GRADUAL COMPRESSION, UNISEX, COTTON SOCKS

## UNISEX GRADUAL COMPRESSION COTTON SOCKS

High quality knee socks made of soft cotton combined with elastic fibres to provide proper gradual compression. Special attention was applied to the development of this cotton product line to ensure maximum fibre quality, along with a soft elastic cuff that offers excellent levels of expandibility: all to ensure maximum comfort and wellness throughout the day.

This product line is available in two compression levels (medium and strong) and in two colours (black and blue). On request, for quantities of 100 or more they are also available in light and extra strong compression and beige and grey colours.

**Medium compression level: 14-16 mm/Hg at the ankle**  
To help prevent discomfort and heaviness in the legs.  
Composition: 67% cotton, 26% polyamide, 7% elastane.

**High compression level: 15-21 mm/Hg at the ankle**  
To help prevent the onset of venous disease.  
Composition: 63% cotton, 27% polyamide, 10% elastane.  
It is a Medical Device.



Multilingual box and instructions: GB, FR, IT, ES, PT, DE, GR, HU



GRADUAL COMPRESSION COTTON SOCKS - pair					
MEDIUM COMPRESSION SOCKS					
Colour	Small	Medium	Large	X-Large	XX-Large
Black	41220	41221	41222	41223	41224
Dark blue	41225	41226	41227	41228	41229
STRONG COMPRESSION SOCKS					
Colour	Small	Medium	Large	X-Large	XX-Large
Black	41240	41241	41242	41243	41244
Dark blue	41245	41246	41247	41248	41249
Shoe size					
European	37 - 39	39 - 41	41 - 43	43 - 45	45 - 47
US - Men	5 - 6½	6½ - 8	8 - 9½	9½ - 11	11 - 12½
US - Women	6½ - 8	8 - 10	10 & over	-	-



# SUPPORT SHEER LINE

Knee Socks, Stockings and Tights designed for dynamic women who need the preventive action of elastic compression but don't want to compromise on style.

This elegant product line features a true heel, an anti-shrink cuff and super soft fabrics. Available in two compression levels (medium and strong) and in beige or black.

**Medium compression level: 70 den - 10-14 mm/Hg at the ankle**  
Ideal for those who would like to initiate a prevention programme, but are mainly interested in the comfort and well-being offered by elastic compression stockings.  
Composition: 84% polyamide, 16% elastane (Stay ups, Pantyhoses).  
85% polyamide, 15% elastane (Knee-highs).

**Strong compression level: 140 den - 15-21 mm/Hg at the ankle**  
Ideal for those suffering from the initial signs of ankle swelling and discomfort.

This level of compression is recommended for initial onset of varicose veins. The product's compression level supports and massages the leg, providing effective relief throughout the day. While this product line boasts an elegant design, particular attention has also been paid to maximum elasticity, which is ensured through the use of a honeycomb fabric (net fabric).

Doctor consult is recommended before use.  
Composition: 79% polyamide, 21% elastane.  
These products are Medical Devices.



Multilingual box and instructions: GB, FR, IT, ES, PT, DE, GR, HU

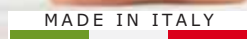

Knee-high with a gradual compression, comfort top, honeycomb mesh



Multilingual box and instructions: GB, FR, IT, ES, PT, DE, GR, HU



Stay ups with gradual compression, silicone lace top, honeycomb mesh



Multilingual box and instructions: GB, FR, IT, ES, PT, DE, GR, HU, NL



Pantyhose with gradual compression, reinforced body, honeycomb mesh

KNEE-HIGHS - pair		
MEDIUM COMPRESSION		
Colour	Small/Medium	Large/X-Large
Black	41100	41101
Beige	41102	41103
STRONG COMPRESSION		
Colour	Small/Medium	Large/X-Large
Black	41106	41107
Beige	41108	41109

STAY UPS - pair				
MEDIUM COMPRESSION				
Colour	Small	Medium	Large	X-Large
Black	41120	41121	41122	41123
Beige	41124	41125	41126	41127
STRONG COMPRESSION				
Colour	Small	Medium	Large	X-Large
Black	41132	41133	41134	41135
Beige	41136	41137	41138	41139

PANTYHOSES					
MEDIUM COMPRESSION					
Colour	Small	Medium	Large	X-Large	XX-Large
Black	41150	41151	41152	41153	41154
Beige	41155	41156	41157	41158	41159
STRONG COMPRESSION					
Colour	Small	Medium	Large	X-Large	XX-Large
Black	41165	41166	41167	41168	41169
Beige	41170	41171	41172	41173	41174

# ANTI-EMBOLISM ELASTIC STOCKINGS

Stockings for prophylaxis of thromboembolism before, during and after surgery.

Thanks to their descending graduated compression, these stockings are an excellent means of preventing increased blood viscosity, which can lead to the formation of thrombus. In order to guarantee a good fit and properly graduated compression, a great deal of attention has been applied to ensuring the high elasticity of the fabrics.

**Recommendations:**

- a valid aid in preventing thromboembolisms linked to surgical interventions
- treatments associated with post-traumatic therapies
- bruises, sprains and hydrostatic edemas

**Counter-indications:**

- localized dermatitis, erythema, necrosis
- stripping, pulmonary edema, grafts
- vascular disorders of cardiac origin
- legs of larger circumference

**Features:**

- decreasing compression from the ankle to the thigh
- true anatomic heel
- super soft elastic fabric, hypoallergenic (latex free)
- inspection opening on top of the foot

Composition: 82% polyamide, 18% elastane. These products are Medical Devices.

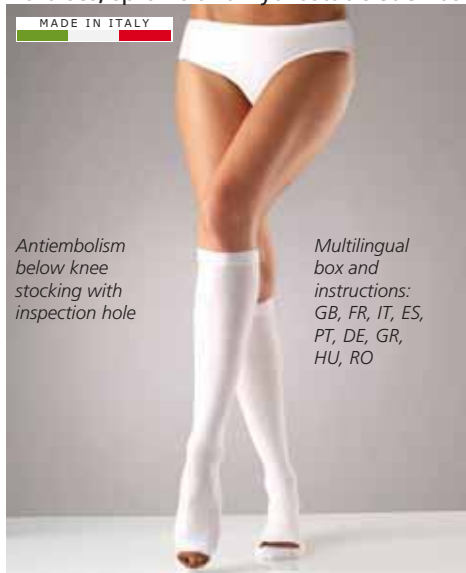

**BELOW KNEE - pair**

COMPRESSION mm/Hg 18-20 (at the ankle)				
Length	Small	Medium	Large	X-Large
38-43 cm	41310	41311	41312	41313



**THIGH LENGTH - pair**

COMPRESSION mm/Hg 18-20 (at the ankle)				
Length	Small	Medium	Large	X-Large
60-70 cm	41316	41317	41318	41319
70-80 cm	41320	41321	41322	41323
80-90 cm	41324	41325	41326	41327



**FULL LENGTH**

COMPRESSION mm/Hg 18-20 (at the ankle)				
Length	Small	Medium	Large	X-Large
70-80 cm	41330	41331	41332	41333

# FUNNY COMPRESSION SOCKS - NYLON-POLYESTER



41200 (S-M size)

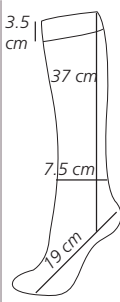

41200-1



41201 (S-M size)



41205 (L-XL size)

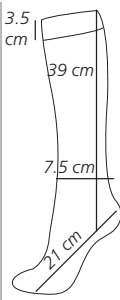

41205-6



41206 (L-XL size)



**FUNNY COMPRESSION SOCKS**  
 Colourful knee-high socks with graduated compression to improve blood circulation. Unique pattern and ergonomic design. Made of nylon and polyester which make socks breathable and moisture absorbent. Each pack includes 5 mixed pairs of socks. Compression level: 15-20 mm/Hg.

GIMA code	FUNNY COMPRESSION SOCKS	Size	Minimum order
41200	Funny pattern 1	S-M	box of 5
41201	Funny pattern 2	S-M	box of 5
41205	Funny pattern 5	L-XL	box of 5
41206	Funny pattern 6	L-XL	box of 5

**BENEFITS:** IMPROVE BLOOD CIRCULATION INCREASE ENERGY ALL DAY SUPPORT LEG PAIN AND FATIGUE

Multilingual instructions: GB, FR, IT, ES, PT, DE, PL, SE, GR

## BATH/SHOWER STOOLS



42900

• **42900 SHOWER STOOL - fixed**  
Shower stool with aluminium frame and plastic seat 50x30 cm. Height adjustable 35-45 cm. Non slip end. Load: 100 kg



42901

• **42901 SHOWER STOOL - foldable**  
Shower stool with aluminium frame and plastic seat 50x30 cm. Height adjustable 44-47.5 cm. Non slip end. Load: 100 kg



42903

• **42903 SHOWER STOOL**  
Shower stool with aluminium frame and plastic seat Ø 32.5 cm. Height adjustable 38-56 cm. Non slip end. Load: 100 kg.



Adjustable seat 54.4 - 71.6 cm with 8 height adjustments, by 2.5 cm (1") increment

27733

• **27733 ADJUSTABLE SWIVEL STOOL WITH HANDLE**  
- swivel seat with 90 degree position lock at every right angle location  
- non-slip central seat pad and soft under-covers  
- load 135 kg (300 lbs)

• **42905 SHOWER STOOL WITH ARMRESTS**

Shower stool made of silver aluminium frame with PU seat, foam armrest and adjustable foot tube. Weight: 4.0 kg Load: 136 kg Size: 44.8-47.2x50-52.6x h 62.2-72 cm Multilingual manual: GB, FR, IT, ES, PT, DE, SE, GR.



33.7 cm 40.7 cm

42905

## BATH STEPS

• **42920 BATH STEP - 1 step**  
• **42921 BATH STEP - 2 steps**  
Stainless steel frame and plastic steps. Load: 100 kg



42920

Size: 27x41xh 14 cm



42921

Size: 51x41xh14-29 cm

## SAFETY SUCTION GRAB BARS



28974

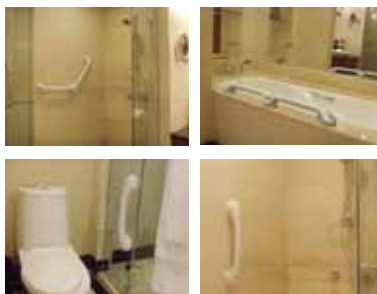

28972



28973

**VISIBLE SAFETY**  
GREEN means well attached  
RED is a warning signal. Need re-mount

• **28972 SAFETY GRAB BAR - 443 mm**  
• **28973 SAFETY GRAB BAR - 545 mm**  
• **28974 SAFETY DOUBLE GRAB BAR - 929 mm**  
Innovative line of GRAB BAR, can be quickly installed everywhere without need of drilling and screwing. Patented suction cups (Ø 93 mm). Holds up to 60 kg (28972/3) or 85 kg (28974) vertical and 45 or 60 kg (28974) lateral weight (tested by SGS). Ideal solution to support elder people during daily bathroom use. Top quality product made of heavy duty ABS, with patented "green/red" suction indicator for better safety. Multilingual box and manual: GB, FR, IT, ES, PT, DE, GR, Arabic.

## PLASTIC RIBBED GRAB BAR

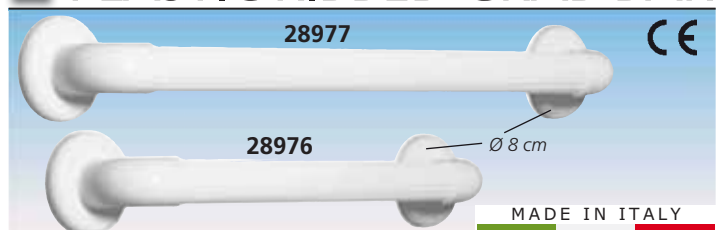

28977

28976

MADE IN ITALY

• **28975 PLASTIC RIBBED GRAB BAR - 30 cm**  
• **28976 PLASTIC RIBBED GRAB BAR - 45 cm**  
• **28977 PLASTIC RIBBED GRAB BAR - 60 cm**  
Ribbed plastic grab bar in Medical PVC, complete with ABS mounting plates and screw covers. Wall screws not included. Electrically isolated. The ribbed bars offer excellent anti-slip grid and are warm to the touch. Can be mounted either horizontally or vertically. Tube Ø 3.5 cm. Max user weight 120 kg (265 lb). Manual: GB, IT.

## U-SHAPE FOLDING BAR

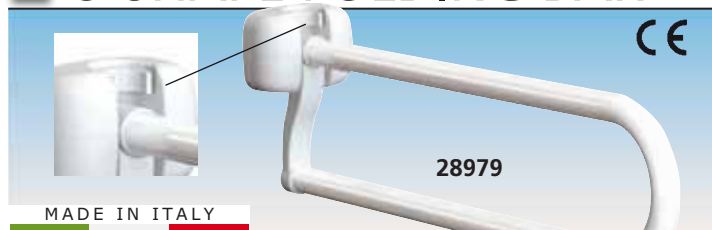

28979

MADE IN ITALY

• **28979 U-SHAPE POWDER COATED STEEL FOLDING BAR - 70 cm**  
White powder coated wall mounted lift up toilet support. Designed to help getting up or transferring to and from the toilet. It can be folded upwards for easy accessibility. Max user weight 125 kg (275 lb). Wall screws not included. Manual: GB, FR, IT, ES, DE, GR.

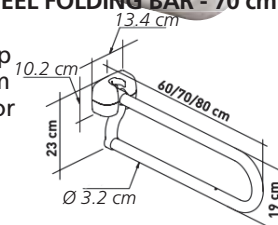

## BATH/SHOWER CHAIRS



27730

• **27730 SHOWER CHAIR with backrest**  
Aluminium frame, seat and backrest in plastic material. Height adjustable (35-45 cm), non slip end. Load: 100 kg.



42906

• **42906 REINFORCED SHOWER CHAIR with backrest**  
Aluminium frame, seat and backrest in plastic material. Height adjustable (42-52 cm), non slip end. Load: 150 kg.



42907

• **42907 SHOWER CHAIR with backrest and armrest**  
Aluminium frame, seat and backrest in plastic material. Height adjustable (41-54 cm). Load: 100 kg.

Multilingual manual:  
GB, FR, IT, ES, PT, DE, SE, GR.



42909

• **42909 SHOWER CHAIR with PU backrest and seat**  
Aluminium silver frame with PU backrest and seat. Height adjustable foot tube. Load: 136 kg. Weight: 4 kg.

## SHOWER COMMUNE CHAIR

• **42913 AQ-TICA SHOWER AND TOILET CHAIR - dark grey/white**  
Two function chair: body care and personal hygiene. It can be used as a toilet chair or as a shower chair. Delivered as a kit in a retail box can easily be mounted without any tools. Rust free structure made of aluminium and polypropylene. Supplied with hygienic pan with lid.

MADE IN FRANCE

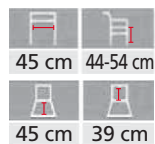

42913

## ROTATING SHOWER CHAIR

• **42912 ROTATING SHOWER CHAIR**  
Height adjustable and 360° rotating seat chair. Swing-up armrests make patient transfer easier. The lever locks the seat in 4 different positions. Aluminium silver frame with comfortable PU padded seat and backrest. Foam arm pad. It can be folded.  
Seat dimension: 40.7x33.7x h 5 cm  
Max load: 136 kg. Weight: 5.3 kg.  
Packing size: 52.5x36x h 42.5 cm  
Folding dimension: 51x34.5xh 40 cm.  
Multilingual manual: GB, FR, IT, ES, PT, DE, SE, GR.



42912

## SHOWER COMMUNE WHEELCHAIR

• **42915 SHOWER COMMUNE WHEELCHAIR**  
Foldable shower commode wheelchair with white painted aluminium frame and plastic seat. Flip-up armrest and lockable front castors. Size: 75x44x48 cm  
Packing size: 67x29x53 cm  
Weight: 6 kg.  
Load: 100 kg.

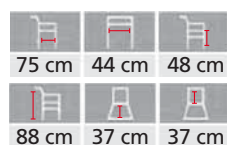

42915

## BATH CHAIR

• **27755 SWIVEL BATH CHAIR**  
Revolving bath chair at 360° with 4 positions for easier access to bath. Polypropylene seat. Frame in painted steel, rotation system in stainless steel. Load: 100 kg. Weight: 5.5 kg.

MADE IN ITALY

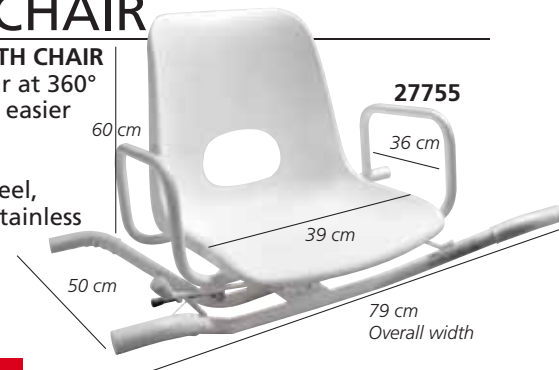

27755

## BATH SEAT

• **42910 BATH SEAT - adjustable**  
Aluminium frame and plastic seat (41x23 cm)  
Load: 100 kg.

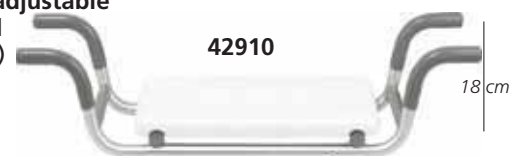

73-78 cm adjustable

42910

## RAISED TOILET SEATS



**27750**  
 • **27750 RAISED TOILET SEAT** height 12.5 cm with fixing system (front screw) and fixed armrest made of anodized aluminium. Max load 130 kg (286.6 lb). Packing: 410x165x468 mm



**27751**  
 • **27751 RAISED TOILET SEAT** height 12.5 cm with fixing system (back and front screw) and anodized aluminium reclining armrest. Max load 130 kg (286.6 lb). Packing: 410x165x468 mm



**27756**  
 • **27756 CLIPPER RAISED TOILET SEAT** - 11 cm Easily adapts to any toilet bowl. Totally made of injected plastic. 4 fixation clips to secure strongly the seat on the toilet bowl. Max load 185 kg (407 lb).



**27741**  
 • **27741 RAISED TOILET SEAT** - 10 cm with lateral fixing system. Max load 250 kg (551 lb). Packing: 373x128x410 mm



**27740**  
 • **27740 RAISED TOILET SEAT** - 15 cm with lateral fixing system. Max load 250 kg (551 lb). Packing: 373x165x410 mm



**27735**  
 • **27735 RAISED TOILET SEAT with LID** - 10 cm  
 • **27737 RAISED TOILET SEAT with LID** - 15 cm with lateral fixing system. Max load 250 kg (551 lb). Packing: 373x128x410 mm (27735) 373x165x410 mm (27737)

## CONTACT PLUS SOFT RAISED TOILET SEATS

• **27743 CONTACT PLUS SOFT RAISED TOILET SEAT**  
 • **27745 CONTACT PLUS SOFT RAISED TOILET SEAT - with lid**  
 High quality soft toilet raiser, made of high-density foam injected in a waterproof PVC skin. It fits any toilet bowl in a very secure way. This comfortable seat with ergonomic shape and high density foam, raises the toilet by 11 cm (4.3 inches). Tested for 185 kg (407 lb).



Cross section view

Exclusive comfort

Fits most toilet bowls



Dimension	width	depth	height
Outside	37 cm	41 cm	16 cm
Inside	21 cm	26 cm	16 cm



27745

## WC - SHOWER COMMUNE



Weight: 5.5 kg  
 Load: 100 kg

Height adjustable  
 83 - 93 cm

38 cm

Height adjustable  
**27758**  
 45 - 55 cm

42 cm

63 cm

**27759**

48 cm

45 cm

• **27758 BATH BENCH with backrest** Aluminium frame and padded seat. Removable plastic bowl WC.

• **27759 WC - SHOWER COMMUNE** Suitable also as raised toilet seat. Adjustable height 45-55 cm (back 78-88 cm)  
 • **27766 PLASTIC WC BOWL - spare**

## CLIPUP® TOILET RAISER



Delivered with 6 antislip SBS pads.

Patented fastening system with ratchet

MADE IN FRANCE



**27738**

• **27738 CLIPUP® TOILET RAISER** - autoclavable ClipUp® can be installed safely on any type of toilet bowl. Innovating fixation system with ratchet. Design with front cutout provides optimal comfort and facilitates personal hygiene. Max Load 150 kg.

TECHNICAL SPECIFICATIONS	
Size: width 34 to 37 cm	Seat opening (depth x width): 26x16 to 19 cm
depth 38.5 cm	Toilet elevation: 10 cm
height 14 cm	Weight: 0.872 kg
Packing: 45.5x16.5x 39.5 cm	Material: 100% polypropylene

## COMMODE WHEELCHAIRS

Packing size:  
54.5x19x76 cm  
Weight: 7.7 kg



**43196**  
4 castors Ø 10 cm  
(4 ")

Packing size:  
72x58x36 cm  
Weight: 8.8 kg



**43198**  
4 castors Ø 10 cm  
(4 ")

• **43196 BLUE COMMODOE WHEELCHAIR**  
• **43198 SMART COMMODOE WHEELCHAIR**  
Made of aluminium with anodized surface. Fixed height. Equipped with 4 castors with brakes, one large footrest, and pan with lid. Indoor use.  
Multilingual manual: GB, FR, IT, ES, PT, DE.

GIMA code						
43196	82	92	56.5	51	46	45
43198	96	100	60	53	52	50

## ELITE COMMODOE



**43203**

Size:  
54x88x105 cm  
Weight: 21 kg  
Load: 100 kg

**43203**  
Supplied with plastic pan



4 wheels Ø 20 cm (2 with brake)

• **43203 ELITE 200 COMMODOE - 43 cm**  
• **43204 ELITE 200 COMMODOE - 53 cm**  
- chromed steel frame  
- blue, washable, flame retardant leatherette  
- adjustable length and raising footrest  
- removable armrest - reclining backrest

## COMMODE CHAIRS

• **27701 COMMODOE CHAIR - chromed steel**  
Chromed steel chair frame, with plastic detachable commode seat.  
• **27702 COMMODOE WHEELCHAIR - painted**  
Powder coated steel frame, detachable armrest and footrest, solid rear castors with lock, plastic commode seat.  
• **27703 COMMODOE WHEELCHAIR - stainless steel**  
Stainless steel chair frame, detachable armrest and footrest, rear castors with lock, plastic commode seat.  
Multilingual manual: GB, FR, IT, ES.  
• **27699 FOOTREST for 27702 - pair**  
• **27700 FOOTREST for 27703 - pair**  
• **27766 PLASTIC WC BOWL - spare - Ø 26xh 15 cm**



**27701**



**27702**



**27703**

GIMA code												
27702/3	55	44	12.5	12.5	51	88	90	44	42	100	54x53x53	17 18
27701	56	44			47	94		43	38	100	50x19x75	8.5

## COMMODE AND SHOWER CHAIR

• **43193 COMMODOE AND SHOWER CHAIR**  
3 in 1 aluminium lifting chair which can be used as raised toilet seat, commode chair and shower chair. Designed with spring-loaded uplift mechanism and safety lock, that help users to stand up, pushing on the armrests. Self-powered, lean forward armrests for easy exit. Anti-slip tips with height adjustable legs. Delivered with bucket, bucket cover and splash-shield.  
Multilingual manual: GB, FR, IT, ES, PT, DE, SE, GR.

Cushion and backrest made of waterproof durable quality PU foam

**3 IN 1:  
COMMODOE CHAIR,  
SHOWER CHAIR  
TOILET RAISER**



**43193**

Adjustable seat height

Spring-loaded uplift mechanism

Self powered, lean forward armrest for easy exit

Rugged, rust-proof aluminium frame

**TECHNICAL SPECIFICATIONS**  
Width: 52-55.8 cm  
Depth: 69.2-73 cm  
Height: 85-95.5 cm  
Packing: 64.5x58.5x39.5 cm  
Max load: 136 kg - Weight: 7.1 kg

## COMFORT COMMODOE

• **43190 COMFORT COMMODOE CHAIR - blue**  
• **43191 COMFORT COMMODOE CHAIR - height adjustable - blue**  
Padded and removable seat for best comfort and high level of hygiene. Pan is removable from both sides and from the top.



**43190**

Removable seatplate

Weight: 6.6 kg

Comfortable padding

MADE IN FRANCE

**MAX LOAD 130 kg**

**TECHNICAL SPECIFICATIONS**  
Total height: 85.5 or 85.5/97 cm  
Width between armrests: 56 cm  
Total width: 63 cm  
Height armrest-floor: 71 or 71/83 cm  
Height seat-floor: 50 or 50/63 cm  
Height seat-backrest: 40 cm  
Seat plate depth: 39 cm  
Total depth: 49 cm

## QUALITY STICKS



### BEECHWOOD STICKS:

- 27760 GIOTTO CURVED HANDLE - man - brown
  - 27761 GIOTTO CURVED HANDLE - woman - brown
  - 27762 RAFFAELLO "T" HANDLE - man - brown
  - 27763 RAFFAELLO "T" HANDLE - woman - brown
  - 27734 RAFFAELLO "T" RIGHT HANDLE - unisex - turtle
  - 27764 TIZIANO CURVED HANDLE - unisex - horn style
  - 27765 TIZIANO "T" HANDLE - unisex - horn style
  - 27768 LEONARDO METAL CURVED HANDLE - unisex - black
  - 27736 LEONARDO METAL ENGRAVED "T" HANDLE - unisex - black
  - 27772 TIEPOLO CHROMED "DUCK" HANDLE - unisex - black
- Max load for wooden sticks: 100 kg. Height: 92 cm\*.  
\*Can change from 90 to 96 cm depending on rubber tip and handle

## WALKING STICKS



- 27779 "T" HANDLE ALUMINIUM WALKING STICK - bronze  
Adjustable height: 72-94 cm - weight 0.4 kg - max load 120 kg
- 27780 "T" HANDLE ALUMINIUM WALKING STICK - silver  
Adjustable height: 71-94 cm - weight 0.36 kg - max load 100 kg
- 27781 "T" HANDLE ALUMINIUM WALKING STICK - black  
Adjustable height: 67-90 cm - weight 0.3 kg - max load 100 kg
- 27782 FOLDABLE ALUMINIUM WALKING STICK - coffee  
Adjustable height: 80-90 cm - weight 0.37 kg - max load 100 kg
- 27783 FOLDABLE ALUMINIUM WALKING STICK - cashmere pattern  
Adjustable height: 86-96 cm - weight 0.36 kg - max load 110 kg
- 27784 CURVED HANDLE ALUMINIUM WALKING STICK  
Adjustable height: 77-100 cm - weight: 0.32 kg - max load 100 kg
- 27795 RUBBER FERRULES int. Ø 19 mm - grey for 27780-2, 27793 - bag of 5
- 27796 RUBBER FERRULES int. Ø 16 mm - grey for 27790, 43065, 43070 - bag of 5

## QUALITY STICKS

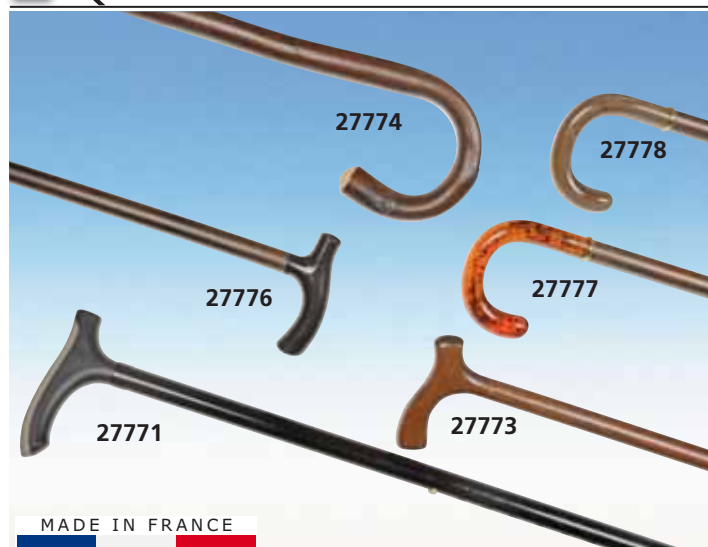

### WOODEN STICKS

- 27773 "T" HANDLE - wooden - max load 120 kg
- 27774 CROOK - chestnut - max load 100 kg

### SYNTHETIC STICKS

- 27776 "T" HANDLE - black - load 120 kg
- 27777 CROOK - amber style - load 100 kg
- 27778 CROOK - horn style - load 100 kg

### ALUMINIUM WALKING STICK

- 27771 "T" ADVANCE - grey  
Aluminium height adjustable cane 745-975 mm with comfortable gel-grip to reduce hand stress. Max load 110 kg.



## SPARE RUBBER TIPS



**SPARE TIPS FOR STICKS, CRUTCHES, TRIPODS AND QUAD CANES**  
Wide range of spare tips that improve performance in term of comfort, grip, durability and adaptability to the ground.

RUBBER TIPS				
GIMA code	Tube	Base	Material	Minimum order
43080	Ø 16 mm	Ø 35 mm	thermoplastic rubber	bag of 10
43081	Ø 16 mm	Ø 35 mm	thermoplastic rubber	bag of 10
43082	Ø 19 mm	Ø 35 mm	thermoplastic rubber	bag of 10
43083	Ø 19 mm	Ø 40 mm	thermoplastic rubber	bag of 10
43084	Ø 19 mm	Ø 45 mm	thermoplastic rubber	bag of 10
43085	Ø 19 mm	Ø 47 mm	pure rubber	bag of 2
43086	Ø 19 mm	Ø 55 mm	pure rubber	bag of 2
43087	Ø 16/22 mm	Ø 40 mm	thermoplastic rubber	bag of 2

## SAFETY STRAP

- 43096 UNIVERSAL SAFETY STRAP  
Adaptable safety strap. Button lock.



## SKID-PROOF STICKS WITH LIGHT

- 43044 TRUSTY CANE - silver
  - 43045 TRUSTY CANE - black
- Sturdy, folding cane with built-in lights and extra wide pivoting head with 3 firm and skid-proof bases. Height adjustable 85-97 cm. Large base with Ø 9 cm. Shaft in aluminium (thickness 1.2 mm) Handle in ABS (15 cm). Weight 420 g. Need 3x1.5 V AAA batteries not included.
- 43048 FOOT PADS - kit of 3 - spare



## STICKS WITH LIGHT AND ALARM



## QUADRIPODS AND STICK WITH SEAT



- 43060 STICK WITH SEAT - silver
- Aluminium walking stick with seat, height 84 cm, weight 0.9 kg
- 43065 TRIPOD - silver
- Adjustable height 74-97 cm, weight 0.8 kg
- 43070 QUADRIPOD Q1 with PU handle - aluminium - silver
- Adjustable height 74-97 cm, weight 0.9 kg
- 43071 QUADRIPOD Q2 with small base and PU handle - silver
- Adjustable height: 65-88 cm, weight 0.8 kg
- 43072 QUADRIPOD Q3 with PU handle - bronze
- Adjustable height: 70-88 cm - weight 0.5 kg
- Maximum load for tripod and quadripods: 100 kg
- 27796 RUBBER FERRULE int. Ø 16 mm - grey for 43065, 43070 - bag of 5



## CANE, TRIPOD, QUAD CANE



- ### CANE, TRIPOD AND QUAD CANE WITH ADJUSTABLE HEIGHT
- Walking aids for people who need to relieve the weight from the legs providing stability, higher than a traditional stick.
- 43075 STABLE WALKING CANE
  - 43076 TRIPOD WITH RING HANDGRIP
  - 43077 QUAD CANE WITH RING HANDGRIP
- Stick Structure:** all the bases and the upper sliding tube are in light aluminium alloy. For the quad cane the central tube is made of steel. U-shaped tubes with strong injection-moulded plastic joint to provide strength and stiffness of the base (only 43076-7).
- Tube Locking clip:** locking of the telescopic tubes with a clip equipped with a double pin; this improves the safety.
- Tapered ring nut:** supplied with a tapered ring nut allowing, by tightening, to eliminate noise.
- Tips:** high grip and have Ø of 35 mm, ISO EN 11334-4. Tip made of high friction material (only 43075)
- Class I Medical Devices 93/42/EEC.

## ELBOW CRUTCHES



- 43100 EVOLUTION CRUTCHES - black - pair
  - 43101 EVOLUTION CRUTCHES - blue - pair
  - 43103 EVOLUTION CRUTCHES - red - pair
- Ergonomic handle and brachial support to enhance safety and quality of arm support while moving around. Aluminium pipes are in light grey anodized finish.
- 43110 PROGRESS 2 CRUTCHES - light grey/grey - pair
- For tall and heavy-weight adults, the handle adjusts from 22 to 29 cm. This crutch is suitable for adults whose height is comprised between 160 and 215 cm.
- 43115 TIKI CRUTCHES - blue/orange - pair
  - 43116 TIKI CRUTCHES - red/blue - pair
- For children or teenagers. The handle adjusts from 16 to 21 cm.
- 43120 RUBBER PVC FERRULES inside Ø 19 mm - grey - bag of 10

### TECHNICAL SPECIFICATIONS

Model	EVOLUTION	PROGRESS 2	TIKI
Weight kg:	0.5	0.5	0.35
Height handle to floor cm:	77-98	79-101	55-77
Material of handle:	Polypropylene		
Diameter upper/down pipe mm:	22/19	22/19	22/19
Number of adjustment of height:	10 times adjustable every 20 mm		
Finishing/material:	grey anodization/aluminium		
Certified and tested for kg:	130	150	100
Standard used for testing:	EN ISO 11334-1		
Adjustable handgrip:	-	4 times	3 times
Handgrip size: Ø x l x h mm	35x100x235	35x100x220/290	32x100x160/210

## ADVANCE ELBOW CRUTCHES

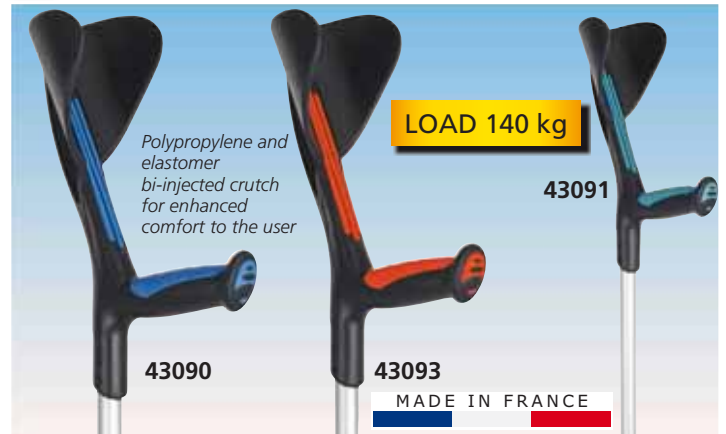

- 43090 ADVANCE CRUTCHES - blue/black - pair
  - 43091 ADVANCE CRUTCHES - turquoise/black - pair
  - 43093 ADVANCE CRUTCHES - red/black - pair
- Advance is the first polypropylene and elastomer bi-injected crutch, bringing enhanced comfort to the user. Certified and tested up to 140 kg. Adjustable in height 10 times per clip. Integrated anti-noise cap and Pivoflex tip.
- 43121 PIVOFLEX TIP - box of 10 - spare
- Inner Ø 19 mm, outer Ø 40 mm.

### TECHNICAL SPECIFICATIONS

Weight kg:	0.51
Height handle to floor cm:	77-98 cm
Material of handle:	polypropylene and elastomer
Number of adjustment of height:	10
Tube finishing/material:	anodized aluminium
Certified and tested for kg:	140
Handgrip length cm:	10



**43121**  
High quality tip  
anti-noise

## DOUBLE ADJUSTMENT CRUTCHES



- 43123 DOUBLE ADJUSTMENT CRUTCH - open - pair
  - 43124 DOUBLE ADJUSTMENT CRUTCH - closed - pair
- Designed to improve comfort for people. Optimized handgrip and support angles, in order to achieve an advanced body posture and reduce hand and forearm fatigue. Structure made of light aluminium alloy. Adjustable forearm 22-28 cm. Open or closed arm cuff. The locking of the telescopic tubes is achieved with a clip equipped with a double pin, to improve safety. Tapered ring nut: it allows, by tightening, to eliminate noise.
- 43126 AMBIDEXTROUS HANDGRIP - spare
- Soft ambidextrous handgrip locked by a rotation proof slot-in system, it can be replaced

### TECHNICAL SPECIFICATIONS

Weight:	0,58 kg (43123) - 0,62 kg (43124)	Height: 68-98 cm
Material:	Aluminium alloy	Forearm support: 22-28 cm
Max. load:	150 kg	
Class I Medical Device, 93/42/EEC, ISO EN 11334-1		

## T-BAR AND UNDERARM CRUTCHES

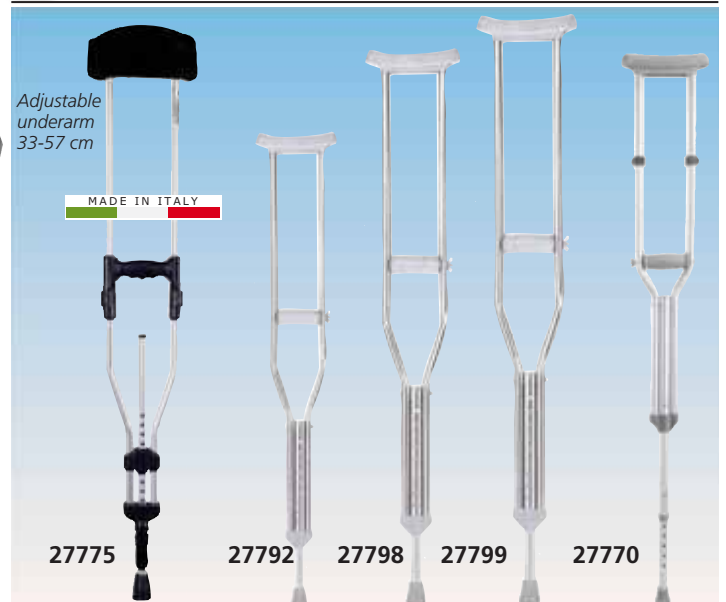

- 27775 DOUBLE ADJUSTMENT UNDERARM CRUTCH - pair
- Light aluminium alloy. Out of center handgrip and washable cover 120-142 cm. Weight 1 kg. Max load 100 kg.
- 27792 T-BAR CRUTCH - small
- Stainless steel type. Adjust. height: 95-115 cm. Max load 100 kg.
- 27798 T-BAR CRUTCH - medium
- Stainless steel type. Adjust. height: 112-132 cm. Max load 100 kg.
- 27799 T-BAR CRUTCH - large
- Stainless steel type. Adjust. height: 119-139 cm. Max load 100 kg.
- 27770 T-BAR CRUTCH - extra adjustability
- Aluminium crutch with adjust. height 100-130 cm. Max load 100 kg.
- 27797 RUBBER FERRULES int. Ø 22 mm grey for 27792/8/9 - bag of 5

## WALKING FRAMES



- **27721 WALKING FRAME - 2 WHEELS**  
Intended to provide support to the patient. It allows mobility making it easy to walk.  
Size 54x57 cm with adjustable height 52-87 cm.  
Instructions: GB, FR, IT, SE.  
Weight: 8 kg - Load: 100 kg.

- **27722 WALKING FRAME**  
Made of lightweight aluminium tubing, non-slip end and padded handgrips.  
Size 47x60 cm foldable with adjustable height 78-96 cm. Instructions: GB, FR, IT, SE.  
Weight: 2.4 kg - Load: 100 kg.
- **27794 RUBBER FERRULES Ø 28 mm - grey** for 27722-3 - bag of 5 pcs.



## WALKING FRAMES WITH WHEELS



- **27723 WALKING FRAME - 2 WHEELS**  
Made of lightweight aluminium tubing, with padded hand grips, 2 non-slip ends and 2 with wheels. Size 51x64 cm, foldable with adjustable height 79-97 cm.  
Instructions: GB, FR, IT, SE.  
Weight: 3 kg - Load: 100 kg.
- **27794 RUBBER FERRULES Ø 28 mm - grey** for 27722-3 - bag of 5 pcs.

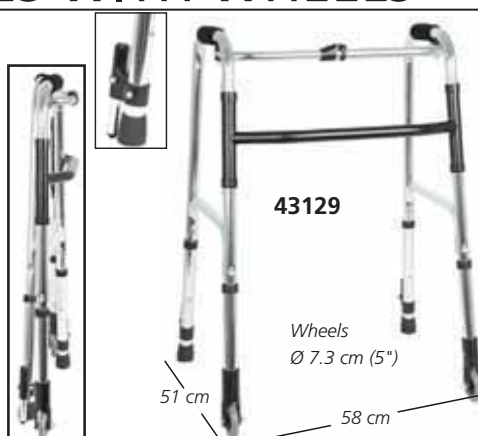

- **43129 WALKING FRAME - 2 INTERNAL WHEELS**  
Made of lightweight aluminium tubing with padded handgrips, 2 non-slip ends and 2 with wheels. Foldable. Adjustable height 80-90 cm.  
Instructions: GB, FR, IT, SE.  
Weight: 2.5 kg - Load: 100 kg.  
Size 51x58 cm.

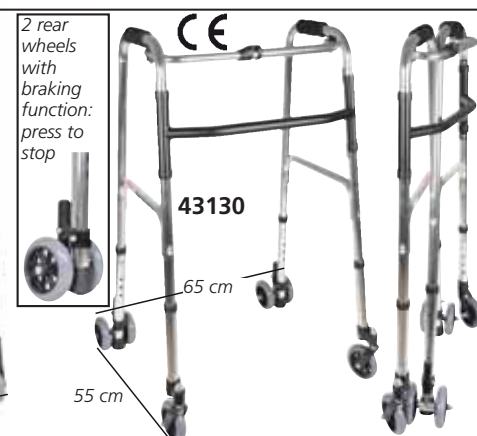

- **43130 WALKING FRAME - 4 WHEELS**  
Made of lightweight aluminium tubing, 2 front swivel wheels, 2 rear wheels with stop, with foam grips.  
Size 55x65 cm foldable with adjustable height 83-93 cm.  
Instructions: GB, FR, IT, SE.  
Weight: 3.5 kg. Load: 100 kg.

## AXILLARY WALKING FRAME



- **43134 AXILLARY WALKING FRAME - 4 WHEELS - blue**  
Walking frame made of steel with 4 wheels and 2 brakes. Equipped with removable seat pad and soft PU foam arm pad.  
Height adjustable armrests 114-139 cm.  
Height adjustable back support 95-110 cm.  
Foldable: 15.5 cm width.  
Frame size: 71x54.5x h 71 cm.  
Max load: 120 kg.  
Weight: 10.5 kg.  
Multilingual manual: GB, FR, IT, ES, PT, DE, SE, GR.

## STAND UP ROLLATOR

- **43172 FULLY ADJUSTABLE STAND UP ROLLATOR**  
It helps adults to stand upright and look ahead with better support.  
Compact one hand folding design, aluminum stable frame, dual hand brake system and fully adjustable armrest, backrest and length.  
Detachable front wheels and stand up handles.  
Padded seat and backrest for more comfort.  
Two front (Ø 25.4 cm) and two rear (Ø 20.3 cm) PVC wheels, cane holder and shopping bag.  
Packing size: 78x28.5xh 45 cm  
Weight: 12 kg. Load: 136 kg.



# ROLLATORS



CE  
Closed size  
59x26.5x68 cm  
without  
handles

43140

Wheels  
Ø 20 cm (8")

Multilingual  
instructions:  
GB, FR, IT, SE

- **43140 3 WHEELS ROLLATOR - blue**  
Blue painted steel, adjustable height frame. With 3 solid castors (2 fixed rear with brake and 1 swivel front). Supplied with shopping basket and tray. Weight: 7.7 kg - Load: 100 kg.
- **43142 IDEAL ROLLATOR - blue**  
Powder coated steel, adjustable height and foldable frame. With 4 solid castors (2 fixed rear and 2 swivel front). Ergonomic handgrip and hand brakes. Supplied with PU foam seat, reflector stickers, shopping basket and tray. Weight: 10.8 kg - Load: 120 kg. Carton size: 590x255x715 mm.
- **43141 CANE HOLDER for 43142**



Adjustable  
height  
78-97 cm

Tray 39x25 cm

CE

43142

Wheels  
Ø 20 cm (8")

66 cm  
Multilingual  
instructions:  
GB, FR, IT, ES



Multilingual  
instructions:  
GB, FR, IT, SE

CE

Weight 7.4 kg  
Load: 100 kg

27724

Front pivoting castors:  
Castors Ø 20 cm (8")

68 cm

61 cm

- **27724 COMFORT ROLLATOR WITH SEAT**  
Foldable frame with seat, large front basket and brakes on wheels. Size 68x61 cm. Adjustable height 78-90 cm. Seat at 46 cm. Seat size: 32x35x4 cm.



Multilingual  
instructions:  
GB, FR, IT, SE

CE

43143

Weight 7.4 kg  
Load: 100 kg

- **43143 SILVER ROLLATOR WITH SEAT**  
Foldable frame with seat, large front basket and brakes on rear wheels. Size 68x61 cm. Adjustable height 78-90 cm.



Weight:  
6.8 kg  
Load:  
136 kg

CE

Adjustable handle  
height 85.5-101 cm

Seat 37x25 cm with  
four adjustable  
heights: from  
53 to 60 cm

43160

PVC wheels  
Ø 20 cm (8")

Multilingual  
instructions:  
GB, FR, IT, ES

- **43160 LIGHTWEIGHT ROLLATOR - foldable**  
Lightweight blue aluminium frame with PP comfortable, adjustable height seat. Handy up seat, padded backrest foldable up and down, wheeled detachable legs. Loop brakes for more safety. Size 56x77 cm. Packing dimension 60x18x58 cm.

## ATTRACTIVE, LIGHTWEIGHT ALUMINIUM ROLLATORS WITH SEAT



Push button height  
adjustment on  
handles 79.5-93 cm

Weight:  
8.5 kg  
Load:  
136 kg

Seat 46x25 cm  
at 54 cm height

43162

Weight: 8.1 kg  
Load: 136 kg

PVC wheels  
Ø 20 cm (8")

CE

- **43162 COMPACT ROLLATOR - foldable**  
Lightweight red aluminium frame, mesh cloth seat with pull up strap. Ergonomic handle and loop brakes for more safety. Cane holder. Two front revolving and fold-up wheels, two rear legs fold up for a very compact folded size. Size 64x66.5 cm. Packing dimension 66x29x37 cm. Multilingual manual: GB, FR, IT, ES.



Push button height  
adjustment on  
handles 79-92 cm

Seat 46x25 cm  
at 53 cm height

43164

PVC wheels  
Ø 20 cm (8")

CE

- **43164 STYLISH ROLLATOR - foldable**  
Lightweight silver aluminium frame, foam padded nylon seat with pull up strap. Ergonomic handle and loop brakes for more safety. Hidden brake cable. Cane holder. Quick release front wheel, rear tubes fold up without any screw for a very compact folded size. Size 66x73 cm. Packing dimension 66x29x37 cm. Multilingual manual: GB, FR, IT, ES.



79 cm

25 cm

Seat 25x45 cm  
at 55 cm height

43166

PU rear wheels  
Ø 20 cm (8")

Load: 136 kg  
Weight: 8 kg

CE

- **43166 PRINCE ROLLATOR - foldable**  
Multifunctional aluminium rollator with silver PU wheels. Equipped with large swivel front and detachable rear wheels, handle height adjustment with brake, cane holder and shopping bag. Packing size: 59x44x21 cm. Multilingual manual: GB, FR, IT, ES.

Comfortable belt filled  
with sponge.

92 cm

Foldable by  
lifting handle

55cm

PU swivel  
front wheels  
Ø 25 cm (10")

70 cm

63 cm

# LIGHTWEIGHT ALUMINIUM FOLDING WHEELCHAIRS



- 27708 PAEDIATRIC WHEELCHAIR - 35 cm seat - black tissue
- single cross bar
- padded flip-up armrest
- fixed footrest, flip-up foot plate with leg strap
- 15 cm (6") solid front castors
- 56 cm (22") pneumatic rear wheels
- locking brakes on rear wheels
- folding back
- large pocket on the back



- 43250 QUEEN ALUMINIUM WHEELCHAIR - 46 cm seat - light blue tissue
- double cross bar
- extra light aluminium frame only 9.5 kg
- fixed armrest, cloth pad
- fixed flip-up footrest with leg strap
- 15 cm (6") front solid castors
- 30 cm (12") pneumatic rear wheels
- folding back
- locking brakes on rear wheels



- 43251 PRINCE ALUMINIUM WHEELCHAIR - 46 cm seat - black tissue
- double cross bar
- fixed armrest, PU pad
- flip-up footrest with leg strap
- locking brakes on rear wheels
- 51 cm (20") PU rear wheels
- 15 cm (6") solid front castors
- folding back
- pocket on the back
- safety belt included



- 43235 CLASSIC ALUMINIUM WHEELCHAIR - 46 cm seat - black tissue
- double cross bar
- padded flipback armrest
- detachable footrest, flip-up plastic plate with leg strap
- 20 cm (8") solid PU front castors
- 61 cm (24") solid PU rear wheels with quick release axles
- Multilingual manual: GB, FR, IT, ES, PT, SE.



- 27720 KING ALUMINIUM WHEELCHAIR - 46 cm seat - black tissue
- double cross bar
- flip-up and height-adjustable armrest, PU pad
- detachable footrest, flip-up plate with leg strap
- 61 cm (24") pneumatic rear wheels with quick release axles
- 15 cm (6") solid front castors
- anti tipper system with 2 small wheels and 2 carrying wheels



- 27717 DELUXE WHEELCHAIR - 46 cm seat - black tissue
- double cross bar
- flip-up height adjustable armrest, PU pad
- detachable footrest, flip-up plate with leg strap
- 61 cm (24") solid PU rear wheels
- 15 cm (6") solid front castors
- locking brakes on rear wheels
- anti tipper system with 2 small wheels

Wheel chair	SPARE - ACCESSORIES				Icons										Weight (kg)	DIM	NA	GW
	Rear wheel	Front wheel	Foot-rest pair	IV stand	1	2	3	4	5	6	7	8	9	10				
27708	27742	-	27710	27705	52	32	35	56	15	48	90	97	36	40	75	85x33x73	13	15
43250	43252	43253	43254	27705	60	29.5	46	30	15	48	90	100	-	-	100	71x28x72	9.5	11
43251	43248	27789	43249	27705	63	29.5	46	51	15	48	91	-	-	-	100	84x31x74	11.8	13.5
43235	43239	43238	43237	-	64	37	46	60	20	46	96	103	42	45.5	120	82x31x96	13	14.5
27720	27787	27791	27728	27705	63	-	46	61	15	50	89	-	-	-	100	83x28x91	17.2	19.4
27717	27748	27791	27714	27705	67	36	46	61	15	51	91	105	40	45	100	80x33x93	17	19

# FOLDING STEEL WHEELCHAIRS



- 43220 VALUE WHEELCHAIR - 41 cm seat - nylon black tissue
- double cross bar
- fixed armrest, PVC pad
- fixed footrest, flip-up plate, with leg strap
- 20 cm (8") solid front wheels
- 61 cm (24") solid rear wheels
- locking brakes on rear wheels
- pocket on the back



- 43225 TRANSIT WHEELCHAIR - 46 cm seat - black tissue
- double cross bar
- fixed armrest, PVC pad
- fixed footrest, flip-up plate, with leg strap
- 15 cm (6") solid front wheels
- 30 cm (12") pneumatic rear wheels
- locking brakes on rear wheels
- handles brakes for rear wheels
- folding back
- pocket on the back



- 43230 NARROW WHEELCHAIR - 41 cm seat - black tissue
- single cross bar
- fixed armrest, PU pad
- detachable footrest, flip-up plate, with leg strap
- 20 cm (8") solid front wheels
- 52 cm (20") pneumatic rear wheels
- locking brakes on rear wheels
- adjustable distance from foot plate to front seat 46-56 cm
- pocket on the back



- 27709 STANDARD WHEELCHAIR - 46 cm seat - blue tissue
- single cross bar
- chromed frame
- fixed armrest, PVC pad
- fixed footrest, flip-up plate with leg strap
- 20 cm (8") solid front castors
- 61 cm (24") solid rear wheels
- locking brakes on rear wheels
- large pocket on the back



- 27715 ROYAL WHEELCHAIR - 46 cm seat - black tissue
- double cross bar
- chromed steel frame
- flip-up armrest, PU pad
- detachable footrest, flip-up plate with leg strap
- 61 cm (24") pneumatic rear wheels with quick release system
- 15 cm (6") solid front castors
- locking brakes on rear wheels
- folding back
- large pocket on the back



- 27716 EXTRA LARGE WHEELCHAIR - 56 cm seat - black tissue
- double cross bar
- powder coated steel frame
- super width 56 cm seat
- flip-up armrest, PU pad
- detachable footrest, flip-up plate with leg strap
- 20 cm (8") rubber foam front castors
- 61 cm (24") pneumatic rear wheels
- large pocket on the back



Wheel chair	SPARE - ACCESSORIES					Icons												DIM	NW	GW
	Rear wheel	Front wheel	Foot-rest pair	IV stand	Table*	1	2	3	4	5	6	7	8	9	10	11	12			
43220	43221	43222	43223	-	-	59	27	41	59	20	47	86					100	95x27x93	15	17
43225	43226	43227	43228	-	-	63		46	53	15	49	91					100	76x30x76	14	16.3
43230	43231	43232	43233	-	-	51	30	41			56	98.5	100	45	38		100	77x31x100	15.8	
27709	27744	27788	27711	27705	27706	64	24	46	58	20	49	87	106	40	45		100	94x23x89	17	19.2
27715	27746	27789	27712	27705	-	64	28	46	61	15	51	94	106	40	45		100	80x28x78	15.8	18.6
27716	27747	-	27713	27705	27706	73	32	56	62	20	54	93	109	45	46		125	83x33x93	21.5	24.1

\* Size of table: 32x55 cm

## ESSEX FOLDING WHEELCHAIRS



Manual: GB, FR, IT, ES, PT, DE, GR, SE



- 43260 ESSEX WHEELCHAIR - 43 cm - black tissue
- 43261 ESSEX WHEELCHAIR - 46 cm - black tissue
- 43262 ESSEX WHEELCHAIR - 51 cm - black tissue

- blue powder coated steel frame
- rear solid PU wheels Ø 30.5 cm (12")
- front solid PU wheels Ø 20 cm (8")
- locking brakes on rear wheels
- front powder steel fork
- padded flip-up armrests
- detachable aluminium footrests with 6 height adjustable clips, flip-up plate, heel straps



Double cross braces (only for code 43262)



### ACCESSORIES FOR ESSEX

- GIMA code
- 43263 Aluminium footplate - pair - spare
  - 43264 Solid PU front wheel - spare
  - 43265 Solid PU rear wheel - spare
  - 43266 PVC arm pad - spare

Wheelchair	Seat			Wheels			Height		Weight		DIM		NW / GW	
43260	58	25	43	30.5	20	50	91	96	40	41	110	76x25x93	16	18
43261	61	25	46	30.5	20	50	91	96	40	41	110	76x25x93	16	18
43262	66	25	51	30.5	20	50	91	96	40	41	110	76x25x93	16	18

## OXFORD FOLDING WHEELCHAIRS



Black nylon seat and back



- 43270 OXFORD WHEELCHAIR - 43 cm - black tissue
- 43271 OXFORD WHEELCHAIR - 46 cm - black tissue
- 43272 OXFORD WHEELCHAIR - 51 cm - black tissue

- blue powder coated steel frame
- pneumatic rear wheels Ø 61 cm (24") with chromed steel handrim and quick release axles
- front solid PU wheels Ø 20 cm (8")
- locking brakes on rear wheels
- front powder steel fork
- padded flip-up armrests
- detachable footrests, flip-up plate, with leg straps



Double cross braces (only 43272 and 43275)

Supplied with pump and manual: GB, FR, IT, ES, PT, DE, GR, SE.

- 43274 OXFORD PLUS WHEELCHAIR - 46 cm - black tissue
- 43275 OXFORD PLUS WHEELCHAIR - 51 cm - black tissue

Same features as above, but with solid PU rear wheels Ø 61 cm (24") and anti tipper system.

### ACCESSORIES FOR OXFORD

- GIMA code
- 43264 Solid PU front wheel - spare for 43270-5
  - 43266 PVC arm pad - spare for 43270-5
  - 43276 Plastic footplate - pair - spare
  - 43277 Pneumatic rear wheel - spare for 43270-2
  - 43278 Solid PU rear wheel - spare for 43274-5



Anti tipper system for 43274-5



Quick release system

Wheelchair	Seat			Wheels			Height		Weight		DIM		NW / GW	
43270	60	26.5	43	61	20	50	91	103	40	44	120	82x27x93	18	20
43271, 43274	63	26.5	46	61	20	50	91	103	40	44	120	82x27x93	18	20
43272, 43275	68	26.5	51	61	20	50	91	103	40	44	120	82x27x93	18	20

## FOLDABLE COMMODORE WHEELCHAIR



### 43283 COMMODORE WHEELCHAIR

Chrome steel structure device ideal for patients with low mobility. It has fixed armrests and footrests, solid castors and sturdy rear wheels. U shape commode seat is extremely durable, suitable for indoor use. Supplied with toilet bowl.

Rear wheels diameter: 58 cm (22").

Front castors diameter: 20 cm (7").

- 27744 SOLID REAR WHEEL - spare
- 27766 PLASTIC WC BOWL Ø 26xh 15 cm - spare
- 43285 PLASTIC FOOT PLATE - pair - spare

Wheelchair	Seat			Wheels			Height		Weight		DIM		NW / GW	
43283	64	44	58	20	50	87	105	37	100	92x29x89	19	21,3		

## ELECTRIC WHEELCHAIRS - FOLDABLE

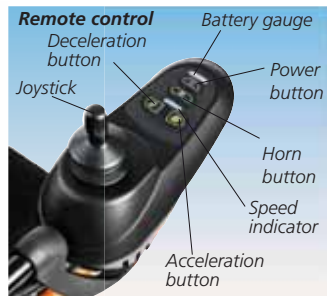

- **43290 ELECTRIC WHEELCHAIR - 30 cm rear castors**
  - **43291 ELECTRIC WHEELCHAIR - 56 cm rear wheels with handrail**
- Electric wheelchair, for daily indoor and outdoor use. It can be used in electric or manual mode, for easy clutch switching. User can move wheelchair forwards, backwards or turn around through an intelligent controller, complete with joystick to control speed and direction. It is provided with aluminium alloy frame, hand rest, foot rest, expandable arm rest and flexible shock-proof suspension. Removable seat and backrest cushions, battery and remote control.
- Comfortable driving** with ergonomic design which relieves fatigue.
- Powerful:** efficient energy-saving motor; high-precision gearbox; fast and stable starting. 5 speed settings.
- Triple protection:** electromagnetic brake and gear self-lock protection.
- Stylish model:** smooth light design characterized by dynamic guard plate, split fixed seat and patented arc-shaped foot rest. Backrest folding mechanism.
- Supplied with lithium battery and charger, manual (GB, IT).
- **43292 LITHIUM BATTERY - spare for 43290-1**
  - **43293 PNEUMATIC FRONT CASTOR 20 cm (8") - spare for 43290-1**
  - **43294 PNEUMATIC REAR CASTOR 30 cm (12") - spare for 43290**
  - **43295 PNEUMATIC REAR WHEEL 56 cm (22") - spare for 43291**



### TECHNICAL SPECIFICATIONS

Load capacity:	≤100 kg
Enduranced mileage:	≥20 km
Maximum speed:	≤6 km/h
Battery:	lithium battery, DC 24V x 18Ah
Motor power:	130 W
Power consumption:	≤2.5 kw x h/100 km
Horizontal brake performance:	≤1.5 m
Maximum safe ramp brake:	≤3.6 m (6°)
Stability:	≥9° (static), ≥6° (dynamic)
Noise:	< 65 dB
Obstacle crossing height:	≥40 mm
Minimum turning radius:	1.2 m
Groove clearance width:	100 mm
Hill-holding performance:	9°
Size:	670 mm - open, 370 mm - closed (43290) 660 mm - open, 360 mm - closed (43291)
Seat width:	440 mm
Net weight:	26 kg (43290) - 29 kg (43291)
Protection:	IPX4

## PEDAL EXERCISERS

Compact exercise bikes for moderate cardiovascular workout. The regular use stimulates blood circulation and increases

muscle strength. Can be placed on a tabletop to exercise arms or on the floor as a bicycle-type exerciser while sitting.

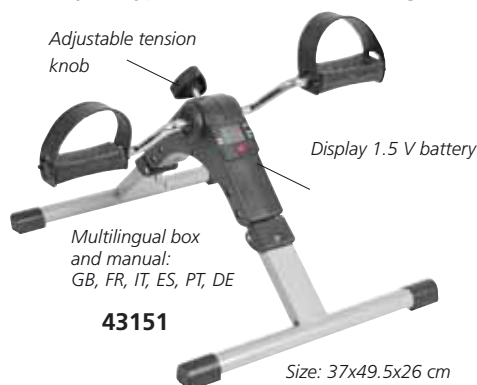
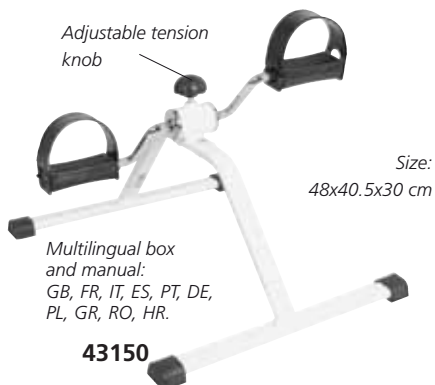

- **43150 BASIC PEDAL EXERCISER**  
Delivered in kit with screw and key for easy assembling.

- **43151 DISPLAY PEDAL EXERCISER**  
Foldable to save space. 5 function display: exercise time, rotation count, rotations per minute, calories burned and scan.

- **43153 ELECTRIC PEDAL EXERCISER WITH DISPLAY**  
Made of ABS and steel with integrated LED display to track and read time, speed and calories. 6 adjustable speed levels. Infrared remote control (battery not included). Power supply: 80 W, 220V-50 Hz.

## UNIVERSAL BELTS FOR ARMCHAIRS, COMMODOES, WHEELCHAIRS

### SMART LINE (43216, 43217)

Padded harness and belt to prevent patient sitting on wheelchair from sliding forward. Equipped with two black propylene webbing (height 5 cm), adjustable up to 100 cm. One-hand release safety clip closure. Harness has two adjustable suspenders with sturdy strap. Class I, Medical Device. Washable at 30°.

Harness size: 60xh 37 cm, max. adjustable length: 260 cm. Belt size: 48xh 15 cm, max. adjustable length: 248 cm.

MADE IN ITALY



• 43216 ABDOMINAL BELT



• 43217 HARNESS

### PREMIUM LINE (43175, 43176, 43177)

Aids used for positioning and handling patients with safety. Equipped with button acetate closure to increase safety level and prevent it from releasing. Ideal for wheelchairs, commodes and armchairs (with 43178).

Coating in class 1 fire-retardant and water-repellent fabric. Washable at max. 40°

• 43178 EXTENDER FOR PREMIUM LINE BELTS - up to 150 cm

Adjustable length.

Necessary for use with armchair.

• 43175 PELVIC BELT



MADE IN ITALY



• 43176 ABDOMINAL BELT



• 43177 HARNESS



## BED RESTRAINT BELTS

100% cotton safety belts used for control of bedridden patient. Equipped with 1 (43185) or 3 (43186-7) safety locks that can be released with a special magnetic key. The belts allow a single (43185-7) or double (43186-7) movement to position the patient in a supine (43185-7) or lateral position (only 43186-7).

Washable at 90° (43185) or 95° (43186-7). Belt height 21 cm.

Safety locks and magnetic key



43185

MADE IN ITALY



43186, 43187



GIMA code	BED RESTRAINT BELTS	Size	Circumference cm
43185	Single movement belt	L-XL	80-122
43186	Double movement belt	S-M	60-88
43187	Double movement belt	L-XL	80-122

## TRANSFER BELT

- 43181 TRANSAC TRANSFER BELT - small
- 43182 TRANSAC TRANSFER BELT - medium

Polyurethane transfer belt to be placed around the patient's or the caregiver's waist, to help the patient sit or stand with minimum effort and maximum safety.

It has 5 vertical and 4 horizontal padded handles with polyester strap and nylon loop. Length: 105 cm (S), 120 cm (M). Transferring load: 160 kg. Washable at 60°.

43182



MADE IN FRANCE

## ROTATING SEAT CUSHION

- 43040 ROTATING SEAT CUSHION

Cushion to assist someone to turn easily in a car, on the bed or on the chair. Size: Ø 40 cm

43040



Slippery nylon filled with PU foam

Upper in 100% polyester



Bottom in non-slip PVC fabric

## PVC WATER MATTRESS

- 28502 PVC WATER MATTRESS

It helps movement and distributes pressure on the whole supporting surface.

Double sealed seams provide maximum strength and durability.

Highly resistant PVC material construction easy to clean with any mild detergent.

Air frame + 3 water elements.

Supplied with hand pump and hose.



28502

### TECHNICAL SPECIFICATIONS

Material: PVC 0.40 mm thickness  
Size of outer air frame: 200x93x11.5 cm  
Size of each element: 69x60x11.5 cm  
Weight: 3.5 kg

## SHAMPOO BASIN

- 28507 SHAMPOO BASIN

Inflatable shampoo basin ideal for personal in-bed hair care needs. It supports the head, neck and shoulders during shampooing. A 20 cm deep basin helps prevent splashing. Drain hose efficiently removes water and foam. Supplied with water bag with shower head in clip.

Size: 53x61x20 cm  
Capacity: 10 l

- 28509 WATER BAG - spare



28509

Bag for easy water transport when water source is not easily accessible

28507

# ANTI-DECUBITUS AIR MATTRESSES WITH PUMP - STAGE I AND II



## ALTERNATING BUBBLE MATTRESS

Designed for the treatment and prevention of pressure sore stage I in short-term and domiciliary therapies. The PVC mattress is composed of 130 7 cm-high bubble cells, particularly comfortable. Fixable to bed by extra flaps on both top and bottom side. Cold-resistant -30 degrees.

## PUMP SYSTEM

Special silent pump for an excellent pressure regulation by a knob on the front panel. It can be hung to any kind of hospital bed frame by means of two adjustable hooks. For use with bubble or alternating cell mattresses. 28565



## ALTERNATING INTERCHANGEABLE CELL-MATTRESS

Recommended for the prevention and treatment of pressure sore stage I and II in medium-term and domiciliary therapies. The 20 9.5 cm-high Nylon+PVC cells provide superior comfort.

GIMA code	MATTRESSES AND PUMP
28564	Bubble mattress
28565	Pump for 28564
28566	Kit bubble mattress+pump (28564+28565)
28567	Interchangeable cell mattress
28568	Pump for 28567
28569	Kit cell mattress+pump (28567+28568)
28570	Spare cell for 28567

Manual and box in 10 languages: GB, FR, IT, ES, DE, PT, PL, HU, GR, Arabic

TECHNICAL SPECIFICATIONS - PUMP	
28565	28568
Size:	25x12xh 10 cm
Operating voltage:	110-220 V, 50-60 Hz
Working pressure:	40-100 mmHg
Air output:	6-7 liter/min
Cycle time:	6 min
Case:	TUV-CE IEC/EN60601-1; 60601-1-2

TECHNICAL SPECIFICATIONS - MATTRESS		
	28564	28567
Total size:	200x90x7 cm	200x86x9.5 cm
Cell height:	7 cm (2.7")	9.5 cm (4")
Material:	PVC	Nylon+PVC
Thickness:	0.32 mm	0.32 mm
Load:	135 kg	140 kg

# THERAPEUTIC ANTI-DECUBITUS MATTRESSES - STAGE III AND IV



- **28575 KIT 5010E ALTERNATING PRESSURE MATTRESS + PUMP** Valuable overlay system designed for prevention and treatment of patients at moderate to intensive risk of pressure ulcers. Pressure is periodically redistributed by inflating and deflating cells in order to mimic natural sleep movement patterns and avoid long term pressurization of tissue. Manual in: GB, FR, IT, ES, PT, DE, PL, RO, SE, GR.
- **28576 CELL for 28575 - spare**

**ALTERNATING FUNCTION**  
The pump inflates and deflates the cells with cyclicity (Group A and Group B as shown in the picture), to change the contact position between the patient and the bed, to promote the blood circulation, to prevent and recover the bedsore, reducing the patient's pain and the nursing labor. Pillow function (28580-2 only): the cells of the head position (Group C) don't alternate, for more comfort to the patient.

TECHNICAL SPECIFICATIONS - PUMPS (28575, 28580, 28582)		
Size:	30x13.5xh 11 cm	Cycle time: 12 min
Operating voltage:	220-240 V, 50 Hz	Working pressure: 55-120 mmHg
Case material:	Flame retardant ABS	Air output: 7-8 liter/min
	TUV-CE IEC/EN60601-1; 60601-1-2	

**PUMP 28580, 28582 only**  
Quick connector with transfer cap to transform mattress into a sealed static surface to facilitate patient transportation.

Quick connector

- **28580 KIT 8010 ALTERNATING PRESSURE MATTRESS + PUMP**
- **28582 KIT 8080 ALTERNATING PRESSURE MATTRESS + PUMP** Advanced systems of alternating pressure mattresses. The multi-mode pump offers:
  - **alternating mode:** the pressure is periodically redistributed by inflating and deflating cells in order to mimic natural sleep movement patterns and avoid long term pressurization of tissue.
  - **constant static mode:** the pressure is about 2/3 lowered when compared to the same pressure level from alternating mode by means of immersion and envelopment. Visual alarms notify the caregiver of unusual situation, reducing the risk of human error. Suitable for the prevention and treatment of all stages of pressure ulcers. Manual in: GB, FR, IT, ES, PT, DE, PL, RO, SE, GR.
- **28581 CELL for 28580 - spare**
- **28583 CELL for 28582 - spare**

TECHNICAL SPECIFICATIONS - MATTRESS			
	28575	28580	28582
Total size:	198x86x12.8 cm	200x86x21 cm	
Alternating	1 in 2 (group A and B)		
Cell height:	12.8 cm (5")	20 cm (8")	
Cover material:	Nylon PU with button	Nylon+PU with cotton lining	
Thickness:	0.4 mm	0.4 mm	0,25 mm
Number of cells:	17+1 spare	20+1 spare	
Cells material:	nylon PVC	nylon PVC	nylon TPU
Load:	150 kg	160 kg	200 kg

# ANTI-DECUBITUS CUSHIONS

MADE IN FRANCE



28530



28534

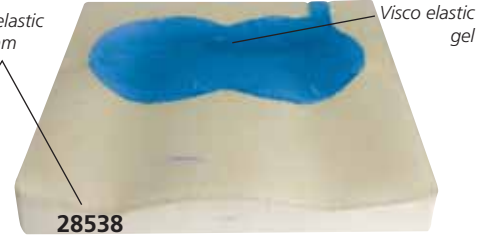

28538



PREVENTION FOR LOW TO MEDIUM DECUBITUS RISK



PREVENTION FOR HIGH DECUBITUS RISK



PREVENTION FOR HIGH TO VERY HIGH DECUBITUS RISK

GIMA line of seat cushions is designed to prevent decubitus risk for patients on wheelchair or permanently on chairs. All cushions in Gel or Foam are supplied with a waterproof PU cover with zipper and handle.

- 28530 BULGEL CUSHION 41x41x3 cm
- 28531 BULGEL CUSHION 43x43x3 cm

This anti-decubitus cushion is made of a flame-resistant pocket including a PE foam core covered by an aqueous gel.

- 28534 VISCO-MOUSS CUSHION 41x41x7\* cm
- 28535 VISCO-MOUSS CUSHION 43x43x7\* cm

Pre-shaped moulded cushion made of viscoelastic foam with memory effect. Memory foam is pressure sensitive and moulds quickly to body shape, returning to its original shape once the pressure is removed. Anatomical shape with raised lateral edges and front-back slope improves positioning, stability and comfort when seated. Foam density: 86 kg/m<sup>3</sup>  
\*Minimum 7 cm, maximum 8 cm

- 28538 GEL AIR 2D CUSHION 41x41x7.5 cm
- 28539 GEL AIR 2D CUSHION 43x43x7.5 cm

Moulded viscoelastic foam base (i.e. Visco Mouss) with a polyurethane gel insert. The viscoelastic fluid gel (blue pad) ensures maximum pressure relief of vulnerable bony areas while the regular gel and the foam increase the contact surface and maximize pressure relief. The cushion's shape ensures a good posture and prevents from sliding forward. Foam density: 86 kg/m<sup>3</sup>

# AIR CUSHIONS

- 28544 GIMA AIR CUSHION - 40x40x6 cm
  - 28546 GIMA AIR CUSHION - 45x45x6 cm
- with polyester cover, pump and repair kit
- single compartment
  - air cells, 64 or 81, prevent pressure sores
  - maximizes pressure distribution and blood flow
  - conforms to the body's shape
  - adjusts to body changes over time.

Max load: 150 kg

Multilingual manual: GB, FR, IT, ES, PT, GR, PL, DE, SE, RO.



PREVENTION FOR HIGH TO VERY HIGH DECUBITUS RISK

# HEEL PROTECTOR

- 28548 HEEL PROTECTOR - 50x22x16 cm

It relieves the heel pressure and prevents decubitus ulcer by increasing the contact surface.

Anatomical shape visco elastic foam including a bactericide and fungicide agent for better hygiene and disinfection.



Density: 90 kg/m<sup>3</sup>

# ANTI-DECUBITUS CUSHIONS AND NECK PILLOWS

MADE IN ITALY

Products to prevent low decubitus risk, made of silicone fibre, coated with 100% preshrunk cotton cover. Main property of

silicone fibre is to maintain original shape also after strong pressure. This allows to maintain comfort and proper weight

distribution in the time. Breathable cotton cover provides maximum cool comfort. Washable at 30-40°C.



28549

Size: 43x45 cm



28550

Size: 45x45 cm



Size: 45x45 cm



Size: 45x45 cm

- 28549 RING SHAPED CUSHION
- 28550 SHAPED CUSHION WITH HOLE

- 28551 3-SECTION CUSHION

- 28552 CUSHION WITH CONCAVE CENTRE

All cushions and pillow are supplied with multilingual instructions: GB, FR, IT, ES, PT, DE



Size: 44x36 cm

- 28555 TRAVEL NECK PILLOW



Size: 32x12 cm

- 28556 HEEL CUSHION



Size: 32x15 cm

- 28557 HEEL CUSHION PLUS

# microline

Material médico e científico Lda

Av. da República, 3000,  
Estoril - Escritório, Bloco B, 2º. Nº 15  
2649 - 517 Alcabideche  
Portugal

Phone: +351 214 533 795

Fax: +351 214 535 681

geral@microline.pt

www.microline.pt

